

A photograph of a wooden boardwalk or bridge structure extending through a lush green forest. The structure is made of weathered wooden planks and runs straight into the distance, flanked by dense green trees and foliage. The sky is clear and blue. The text "Mary to Bay Rail Trail Trail Development Plan" is overlaid in the upper half of the image.

# Mary to Bay Rail Trail Trail Development Plan

Final Report



# MARY TO BAY RAIL TRAIL TRAIL DEVELOPMENT PLAN FINAL REPORT



Prepared by



June 2019

## CONTENTS

EXECUTIVE SUMMARY	4
RECOMMENDATION	5
SECTION 1 – BACKGROUND	6
SECTION 2 – THE SCOPE OF WORKS FOR THIS PROJECT	7
SECTION 3 – TRAIL DESIGN AND DEVELOPMENT CONSIDERATIONS	8
SECTION 4 – WORKS LISTS AND PROBABLE COSTS	33
SECTION 5 – CONSTRUCTION MANAGEMENT	64
SECTION 6 – AN IMPLEMENTATION PROGRAM	70
SECTION 7 – CORRIDOR MANAGEMENT AND OPERATIONS PLAN	74
APPENDIX 1 – ROAD CROSSING DRAWINGS	99
APPENDIX 2 – CROSS SECTIONS AND PHOTOS – GATING SYSTEMS	104
APPENDIX 3 – TRAILHEAD DRAWINGS	107
APPENDIX 4 –TRAIL MAINTENANCE CHECKLIST: AN EXAMPLE	114
APPENDIX 5 – PLANS OF PROPOSED RAIL TRAIL	117

## EXECUTIVE SUMMARY

This Trail Development Plan sets out a detailed set of activities for the progressive construction work to complete the Mary to Bay Rail Trail primarily utilising the disused railway corridor between Maryborough and Hervey Bay (noting that a significant section has already been built – the Links Mobility Corridor between Urangan Pier and Nikenbah, and a newly completed section between Piggford Lane and Walligan Trailhead at Dundowran Road). Section 4.0 contains six tables where a comprehensive works list for each of the proposed stages of the rail trail development is set out, and an estimate of probable costs for each task.

The estimated detailed cost of the project is **\$13,460,110**. The Mary to Bay Trail Feasibility Study (prepared earlier in 2019) provided an estimate of the likely costs involved in establishing the rail trail between Maryborough and Walligan Trailhead (and completing the section from Piggford Lane to Nikenbah). The project was estimated to cost \$12,441,335.

The detailed cost estimates provided in this Trail Development Plan are marginally higher than originally estimated (\$1,018,775 or 8%) and this is not unexpected once detailed fieldwork is undertaken. There are significant difference in section costs due primarily to bridges, fencing and surfacing requirements being different than the original estimates for a range of reasons. The addition of lighting for the section within Maryborough (as requested by FCRC) has added \$573,750 to the overall cost.

For the Feasibility Study, the assessment of the condition of the corridor was done by observations from a distance and inspections where possible at road crossings – the usual level of inspection undertaken during the preparation of a rail trail feasibility study. In preparing the detailed Trail Development Plan, the entire corridor was traversed by foot and as a result much more is known about the requirements to convert the former railway corridor to a rail trail.

There are unknowns when dealing with the construction of rail trails such as this. The extent of approvals needed prior to development of the trail and the requirement for permits and additional studies is not known but an allowance has been made.

There are also a number of interested parties with whom Council will need to negotiate to address and satisfactorily resolve some access issues. This Trail Development Plan has identified these and has identified guidelines for these discussions and negotiations to occur.



## RECOMMENDATION

It is recommended that the Fraser Coast Regional Council use this Trail Development Plan (in conjunction with the Feasibility Study), and other documentation in future funding applications to the Queensland Government.

Should Fraser Coast Regional Council proceed to construct the trail, the entire trail should be called the Mary to Bay Rail Trail (as originally envisaged). The Links Mobility Corridor title has served its purpose and as a name will be redundant once the trail is completed to Maryborough.

## SECTION 1 – BACKGROUND

The proposed Mary to Bay Rail Trail will connect Hervey Bay to Maryborough. A significant portion of the proposed Mary to Bay Rail Trail already exists. There is a 13.5 kilometre rail trail from Urangan Pier to Nikenbah (known locally as the Links Mobility Corridor) and a recently opened 3.5 kilometre section from Piggford Lane to Stockyard Creek. Completion of the proposed Mary to Bay Rail Trail would mean developing a rail trail on the disused railway corridor between Stockyard Creek and Maryborough. There is also the need to develop the section of disused railway corridor between Nikenbah and Piggford Lane. A completed rail trail from Maryborough to Hervey Bay will cover a distance of some 48 kilometres.

In 2017, the Queensland Government released its Queensland Cycling Action Plan in 2017 which committed to the investment of \$14 million over four years to develop and implement a program to deliver rail trails in partnership with local governments on state-owned disused rail corridors. This funding provided an impetus to examine a range of railway corridors which may have the opportunity to be converted to rail trails.

In mid 2018, Fraser Coast Regional Council sought funding under the Queensland Cycling Action Plan to commission a Feasibility Study on completing the Mary to Bay Rail Trail.

A Feasibility Study examining the merit of developing a ‘rail trail’ on the disused railway line was undertaken. (A rail trail is the conversion of a disused railway into a multi-use recreation path, typically for walking, cycling and sometimes horse riding. The characteristics of abandoned railways - flat, long, and frequently running through historical areas - are appealing to numerous potential user groups).

The Feasibility Study set out a number of matters for consideration and included the history of the corridor and recent State Government commitments to developing rail trails on publicly owned railway corridors. It was also informed by a series of Open Houses (or ‘drop in’ sessions) held along the railway corridor in January 2019.

The Feasibility Study found that the completed Mary to Bay (mostly on the railway corridor) was feasible from a technical and economic viewpoint. It was submitted to Fraser Coast Regional Council in February 2019.

In March 2019, Fraser Coast Regional Council accepted the report’s findings and determined to proceed to the next stage of work – a detailed Trail Development Plan.

This Trail Development Plan provides the Council with a construction blueprint, enabling it to proceed with the establishment of the rail trail (should it determine this to be the appropriate course of action) once funds become available.











## SECTION 2 – THE SCOPE OF WORKS FOR THIS PROJECT

This Trail Development Plan provides sufficient detail for a funding application to be prepared and to guide the actual construction once funding has been obtained. The Trail Development Plan is a construction blueprint. The primary focus is on the works necessary to convert the corridor to a rail trail and the ongoing maintenance and funding. The Plan provides examples of already constructed rail trails elsewhere in Australia and overseas. The Trail Development Plan builds on the work undertaken for the Feasibility Study and focusses on detailed design and costings.

This Trail Development Plan provides detailed works lists and detailed cost estimates (item by item, location by location) covering all elements needed to convert the rail corridor to a rail trail - informed by a traverse of the corridor by foot and a limited number of meetings with adjoining landowners (who were afforded the opportunity to meet with the consultants). Construction plans with a list of necessary (and optional) construction items, quantity estimates, materials required, and construction schedules have been prepared.

The main elements of this Trail Development Plan are as follows:

-  Fieldwork, which involved a traverse of the corridor (by foot and vehicle);
-  Identification of alternative routes where necessary;
-  Preparation of detailed works lists and calculation of quantities for construction;
-  Preparation of detailed cost estimates for construction;
-  Basic design and construction guidelines;
-  Preparation of drawings and cross-sections;
-  Mapping of corridor (illustrating construction activity); and
-  Management and maintenance planning. A list of maintenance tasks that need to be attended to have been provided and innovative ways of addressing these tasks have been suggested.

## SECTION 3 – TRAIL DESIGN AND DEVELOPMENT CONSIDERATIONS

### 3.1 GENERAL CONSIDERATIONS

This section of the Trail Development Plan addresses a series of matters relating to trail design and development of the Mary to Bay Rail Trail – to achieve a rail trail that is constructed with minimal disturbance to the natural environment, is sustainable, has minimal impact on adjoining landowners and that requires minimal maintenance.

During construction of the original railway, effective drainage was important, as it is with all public infrastructure. Locating a trail on the formation of the former railway is important, and re-purposing and reinstatement of bridges is vital for the success of the rail trail.

There were originally 13 bridges on the section from Colton to Dundowran Rd, as well as 1 bridge on the section between Piggford Lane and Nikenbah. There was a bridge over Saltwater Creek (which is no longer in place) and it is likely there was a bridge over Dead Man's Gully (some 1.5 kms south of Saltwater Creek). Some have been removed, some were replaced with concrete culverts over the years and some remain. In all instances where the bridges have been removed, replacement with pre-fabricated bridges is recommended. Re-use of existing bridges where these exist is recommended (as has occurred between Piggford Lane and Stockyard Creek).

Construction of the railway involved the cutting and filling of the landscape to create a surface that was relatively flat to enable the passage of steam trains. The result was a series of cuttings and embankments along the entire length of the rail corridor although there are far fewer on this corridor than on most others. Effective drainage will be required, especially within cuttings, to ensure stormwater is quickly and effectively removed from the sides of the trail (as it was when the trains were running).

Culverts and other drainage controls should be used to direct run-off away from the trail. Stormwater must drain freely, and where possible, pass beneath the trail without impact on either the base formation or the surface itself. Rail trails, by their very nature, tend to deal with these problems relatively well. Numerous culverts inspected during fieldwork were completely or partially block (or impenetrable due to vegetation regrowth), thereby inhibiting the free flow of stormwater under and away from the railway embankment. The works lists provide an allowance for the cleaning of these culverts. Ongoing, regular cleaning of blocked culverts is essential to avoid serious soil and water degradation problems.



During construction of the rail trail particular care must be given to reinstating the side (cess) drains through cuttings.

At some point in the past, contractors were engaged to remove the steel railway track and sleepers – probably at the same time the bridges were dismantled. The formation now is overgrown with vegetation regrowth and clearing will be required along much of the corridor to permit the development of the trail.



## 3.2 TRAIL ROUTE AND ALIGNMENT



The Feasibility Study included detailed discussions over a number of route and alignment issues. These issues were:

-  Mining leases over the disused corridor.
-  Trail route north and south of Aldershot; and
-  Trail route from Walker Street into the centre of Maryborough.

The following is provided as a brief overview of the issues and recommended (and accepted) solutions and includes an update based on fieldwork for the Trail Development Plan.

### 3.2.1 MINING LEASES OVER THE DISUSED CORRIDOR

There is an active mining lease over part of the former railway corridor at Colton (primarily between Churchill Mine Road and the disused corridor's intersection with the North Coast Railway Line). The actual mining lease (and the proposed open cut mine) encompasses a large portion of the former railway corridor. Significant lengths of the former railway corridor between Churchill Mine Rd and Colton were also to be used for infrastructure (railway and roads) for the proposed mine. Under the terms of the mining lease, the mining lease holder has the following responsibilities relating to the rail corridor:

-  Responsibility for the identification of an alternative corridor from Churchill Mine Road to Saltwater Creek Road;
-  Responsibility for the acquisition of any land along this alternative corridor; and
-  Responsibility for negotiating with Fraser Coast Regional Council a contribution towards the construction of the rail trail along the alternative corridor.

In October 2018 Colton Coal Pty Ltd was placed in to the hands of administrators, meaning the company may become insolvent.

**Critically the mining leases, whilst they exist, give exclusive rights to the lease holder and therefore access to the rail corridor in this section even in the short-term or until a mine is constructed in this section would not be achievable. This means that a rail trail on the original corridor from Churchill Mine Road to Colton is not achievable.**

Two options were canvassed in the Feasibility Report. The recommended option was to construct the trail on a new route on the northern side of the mining lease area, and parallel to the existing railway corridor. The landform here is similar to the landform through which the existing railway corridor runs. There appears to be no significant technical impediments to such a trail. It will require construction of a new trail – surveying, fencing, vegetation clearing, trail construction. The proposed trail would be outside the boundary of the mining infrastructure

layout (in terms of what is publicly known). This proposed trail route appears to be on State-owned land which may mean that the trail proponent (FCRC) would need to negotiate with the State about gaining an access easement across the land to facilitate a trail. This route would involve a similar distance of travel for users. This option means that the deviation from the original rail trail is minimised.

Fieldwork for the Trail Development Plan has confirmed that a road reserve (Road 21) runs alongside the eastern side of the active North Coast railway line north of Colton siding and south of Colton Siding to Bronze St, Aldershot providing an option to develop the rail trail between Colton and Aldershot, thus avoiding the mining lease area. It is not known whether this road reserve is within the mining lease area. However, if it is on the lease, it is on the western edge (and adjoins the active railway line) and therefore the use of it for a rail trail should not interfere with mining operations. The Trail Development Plan work has proceeded on the basis that this reserve can be utilised to provide the link between Churchill Mine Road and Aldershot. The trail would head west from Churchill Mine Road north of the mining lease and approximately parallel with the old railway formation. The precise route has not been detailed in this report, although the key start and finish points are clearly identified in the works tables. When the trail reaches the active railway line it would turn south west and head along Road 21 road reserve until reaching Bronze Street at Aldershot. Fencing requirements are discussed at 3.13 below.

**This is the recommended route around the mining lease.**

### 3.2.2 A TRAIL ROUTE NORTH AND SOUTH OF ALDERSHOT

---

#### *North of Aldershot*

The original railway corridor north of Saltwater Creek was sold previously. The Feasibility Study examined options for constructing the trail between Saltwater Creek and the southern end of Bronze Street. Further examination of Council's property database indicated that not all of the corridor was sold. There is a thin wedge that runs from Saltwater Creek north for approximately 210 metres. Investigations reveal that this parcel is owned by the State Government and according to a local landholder was retained by the State for the purposes of track alignment for the active railway line. It was never needed but remains in State ownership. The Feasibility Study recommended that an access easement could be negotiated with the landholder of the property adjoining the active corridor. The Feasibility Study estimated some 340 metres would be required; the ownership data means that a strip of approximately 130 metres (x 5 m wide) would be required for the trail (on the basis that the State Government provides access to the parcel it owns). The State-owned property is very narrow at the southern end (next to Saltwater Creek) and discussions with the landholder may need to



include an easement or purchase to ensure that a bridge can be landed on the northern side of the creek (this bridge would be some 50 metres downstream of the active line railway bridge).

It is also proposed that once the trail reaches the southern end of Bronze Street, it will use Bronze Street (the road for cyclists and the grassy verge for walkers and horse riders) as it is too difficult to locate any trail within the active railway corridor.

### *South of Aldershot*

A trail route between Aldershot and Maryborough was extensively examined previously, and the route recommended in the 2012 Vision Statement is not an ideal route given its deviation from the original railway alignment and its proximity to the Bruce Highway.

Examination of Council's property database indicated that Fraser Coast Regional Council owns a large property which runs immediately east of the original railway corridor south of Saltwater Creek (it appears to be used for farming purposes). Whilst the ownership mapping is not perfectly clear, it appears as if the original railway formation is the dividing line between two properties – the one owned by the Council and the one west of the original railway line which is privately owned. The obvious and relatively simple solution is for Council to provide a trail along the western boundary of its property – this may or may not be along the line of the original formation, but it certainly would be within the original railway corridor. This would allow construction of a rail trail between the south bank of Saltwater Creek and Quarry Road. Some negotiations may be required with the adjoining landowner (west of the railway formation), and a land swap or acquisition of land for the trail route may be appropriate, due to the very complicated property boundary created after the railway corridor was sold.

This may also require some changes to rural operations on the Council-owned land, but these are envisaged to be very minor given that the trail would be on the property boundary. Fencing requirements are discussed at 3.13 below.

Two new bridges will be required along this route – over Saltwater Creek and Deadmans Gully.

### 3.2.3 RAIL-WITH-TRAIL IN MARYBOROUGH

---

The recommended route for the proposed rail trail through Maryborough utilises the existing (active) railway corridor. The corridor has ample width for the alignment of a pathway/trail. Throughout Australia, and elsewhere in the world, shared paths have been constructed alongside operating railways without complications.

Even though the railway corridor through Maryborough serves only a handful of trains (at very slow speeds) each week, and it is not electrified, barrier fencing will be required to provide added safety and to prevent trespass. This is discussed further in Section 3.13.

The Feasibility Study strongly recommended that a deviation around the mine is to be the limit of deviations – i.e. the rail corridor would follow the original railway corridor from Aldershot into Maryborough station. The Feasibility Study clearly indicated that the feasibility of the rail trail and the business case are dependent on this critical issue. If other deviations are chosen between Colton and Maryborough, the forecast user numbers in the business case cannot be relied upon. This was accepted and the Trail Development Plan alignments and works lists have been prepared on that basis.



*Trails and paths alongside operating railway lines successfully operate elsewhere in Australia such as in Perth (above left).  
The current use of the railway line in Queens Park operates with very few safety measures (above right).*

### 3.3 TRAIL WIDTH AND HEIGHT

To function effectively as a shared use facility (for cyclists and walkers), the Mary to Bay Rail Trail should have a width of 2.5 metres. A separate bridle trail would be slashed to a width of 1 metre (if the trail is to be used by horse riders). The works list proposes using existing management tracks running parallel with the formation for horse riders in one section. Anything wider than 3 metres and the trail starts resembling a road, which is not what rail trail users want. The width of the existing embankment/formation of the original railway will ultimately determine the width that the proposed rail trail can be constructed in some locations.

The railway has been disused since 1993. During this time many sections of the corridor have become overgrown and will require clearing for the passage of trail users. Where vegetation has regrown, overhead clearance should be maintained to approximately 2.4 metres from the rail trail surface. All overhanging vegetation – and that which intrudes from the sides into this ‘corridor’ should be cut back on a regular basis. Care should be taken that sharp and dangerous ‘points’ are not left in this pruning process.



There are instances where side vegetation can be retained, as the trees are attractive and provide shade. They also provide an attractive vista along the cutting or embankment.

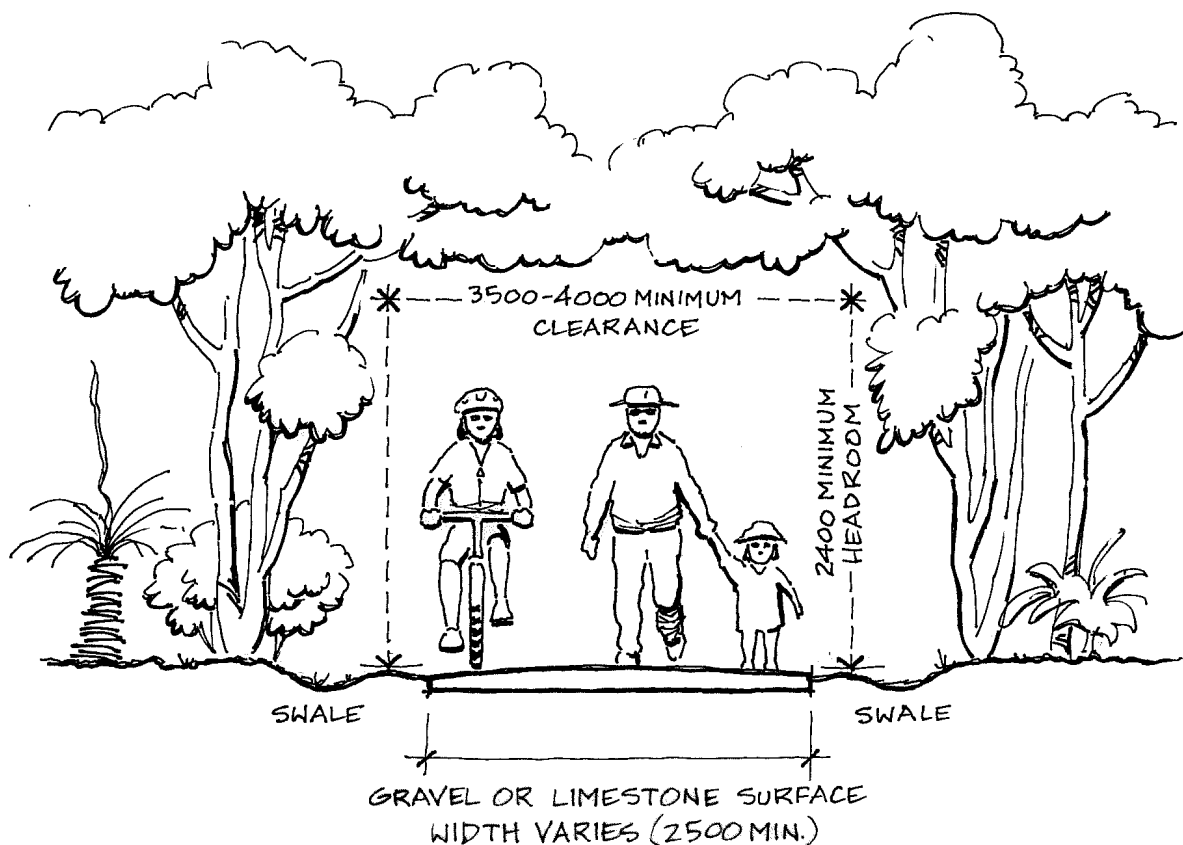

### SHARED USE TRAIL - GENERAL CHARACTERISTICS

#### 3.4 TRAIL SURFACING

A smooth compacted surface is most appropriate for a shared use rail trail. The surface should be firm enough to provide cyclists (the predominant user group of rail trails) with a relatively smooth ride.

Most rail trails developed in Australia use a locally available earth surface (gravel, decomposed granite, crushed limestone, etc.) to produce a firm surface easily capable of accommodating walkers and cyclists.

Some sections of this rail trail can function as an urban commuter path as well as a more traditional rail trail. Sealing the ‘in-town’ sections of the trail is appropriate, and the works lists

makes provision for sealed surfaces at the Maryborough end. It is recommended that the trail be sealed from the Maryborough trailhead (at Alan and June Brown Car Park) to the Maryborough West trailhead (on Slaughterhouse Rd adjacent to the lawn cemetery). The Feasibility Study included a discussion on the relative merits of sealing the entire corridor (noting that this would mean sealing the newly constructed section between Piggford Lane and Stockyard Creek). The works tables (Section 4) provide only for sealing the section between Maryborough and Maryborough West; to seal the remainder of the trail would cost in the order of an additional \$5.3 million. Fraser Coast Regional Council need to make this determination taking into a number of matters discussed in the Feasibility Study.

Alternative surface treatments may also be worth exploring. A number of liquid polymer modified bitumen composition products are currently available and the proponents have indicated that this surfacing treatment can be delivered at a similar cost to a compacted natural surface. Proponents have argued that the two key advantages are that the products re-use the ballast and therefore it does not need to be removed from site and that as a harder wearing surface it has a longer life. Little ballast remains on this corridor so such polymers may not be the appropriate surface.

Grading will be required prior to a surface material being applied. Care should be taken not to create berms of ballast on the side of the trail which have the effect of trapping the water in the trail formation i.e. creating a dam effect. Care should also be taken to ensure in cuttings that the graded material is not simply pushed in to the existing drains on the side of the trail as this will have the effect of preventing the drains from performing as they should. Grading should be followed by the installation of the new surfacing material.

Around 75% of rail trails across Australia are used by walkers and cyclists; the remaining 25% permit use by horse riders. If horses are to be permitted on this trail, it is important to keep horses off the main trail surface as the hooves of horses can do significant damage to unsealed trail – although the level of damage depends on the surfacing material used and the prevailing weather conditions. Some surfacing materials (such as “Lilydale Toppings” as used on the Lilydale Warburton Rail Trail in the Yarra Valley in Victoria) are very accommodating to horses’ hooves.

The most effective method of accommodating horses is by the establishment of a separate bridle trail – usually a signposted, slashed single-track route off to the side of the main trail (but still within the original railway reserve). This is commonly done on rail trails such as the Great Victorian Rail Trail, the High Country Rail Trail (also in Victoria) and others. The bridle trail route can be simply constructed by slashing the low grass. The constant passage of horses will keep the ‘single-track’ clear of regrowth and clearly defined. Bridle trail signage will be required to show riders where to go and to keep them off the main trail. Horses will need to share bridges where they cross watercourses.

In the costs estimates that are included within this Trail Plan (Section 4), an allowance has been made for clearing of the trail corridor (vegetation and top soil and whatever ballast remains), further grading and shaping of the formation to create as smooth a surface as possible, and additional fill material. An allowance has also been included for slashing and flailing a separate horse trail where this is needed.

---

### 3.5 SAFETY CONSIDERATIONS

One of the most significant safety issues is that of potential conflict between users of the proposed rail trail and road users (cars and trucks)– especially at road crossings. This is more fully dealt with in ‘Road Crossings’ (see Section 3.6).

Possible conflicts between different types of trail users is a potential safety issue. Users in conflict can be both legal and illegal – for example, between trail users (walkers and cyclists) and trail bikes or 4WD’s that have illegally accessed the rail trail. Effective signage and vehicle exclusion barriers (management access gates and chicanes) will greatly limit this potential problem. This may be a particular issue between Colton siding and Walligan trailhead where there is evidence of use of the corridor and the formation by motorbikes and 4WD vehicles.

Dogs can be a potential safety consideration. It is recommended that dogs should be permitted on the trail within the Maryborough town limit (out to Maryborough West trailhead. Fraser Coast Regional Council may determine to extend this boundary to be consistent with the existing trail at the Hervey Bay end of the corridor.

---

### 3.6 ROAD CROSSINGS

Road / trail crossings always present a special hazard which must be addressed carefully. A crossing should have enough space cleared and levelled on both sides of the road to allow cyclists travelling together to gather in a group and cross en masse. One-at-a-time crossing greatly increases the overall time in the roadway and therefore increases the likelihood of encountering a vehicle. The crossing should ideally be at a straight, level area allowing both trail user and vehicle driver good visibility and the driver ample stopping distance (if possible). All trail crossings should be perpendicular to the road.







The 5 road crossing concept drawings that form part of this Trail Development Plan (see Appendix 1) illustrate the signage that is required at each road crossing and the positioning of gates (for management access vehicles and for trail users). With five exceptions (Ferry St, Pallas St, Rocky St, Walker St and Maryborough Hervey Bay Road), all road crossings will be ‘at-grade’, as is common with the overwhelming majority of road crossings on rail trails in Australia (as well as many other trails). The most notable exception is the construction of the underpass

under the Maryborough Hervey Bay Road. Crossing points of the major roads have been located to maximise sight distances and visibility of trail users.

Signs required to create safe road crossing are outlined in Section 3.7. The rail trail should be clearly marked on each side of the road for easy recognition and the crossing be designed to move the trail user away from the road reserve as quickly as possible.

Details pertaining to shared path crossings of roads can be found in *Austroads Guide to Road Design Part 4: Intersections and Crossings – General (Australia)*.

Generally, the road crossing treatment required includes:

-  Installation of signage on the rail trail (both sides of the road crossing) advising (or warning) of the upcoming crossing of the road. The recommended treatment is the installation of (either or both) “Give Way” (or “Stop” signs or pavement markings if it is a major road) and “Road Ahead” signs on both sides of the crossing;
-  “Trail Crossing Warning Signage” on the road (both sides of the trail crossing) alerting road users of the upcoming trail crossing;
-  Management access gates and chicanes (permitting access by legitimate trail users and authorised vehicles, such as emergency services vehicles and management vehicles) in certain locations. A technical drawing setting out the specifications for chicane gates can be found in Appendix 2, as well as a photo of such a gate on the Lilydale Warburton Rail Trail in Victoria. It should be noted that the gating systems proposed differ from those already in place (the vertical posts). The current system of barriers at road crossing is ineffective in preventing motorbike use of the rail trail – something which should be discouraged at the outset;
-  Installation of pipe culverts (where required);
-  Installation of an asphalt ‘apron’ each side of road crossing – basically, a flat, durable sealed surface providing a non-slip and smooth transition from the gravelled trail surface to the asphalt road; and
-  Miscellaneous signage (including Rail Trail name and logo; distance signs; Emergency Marker signs; road name signs; “Unauthorised Vehicles Prohibited” signs; “Trail Bikes Prohibited” signs, etc.).



### 3.7 SIGNAGE

Several kinds of signage are required on the Mary to Bay Rail Trail, including distance, directional, warning, promotional, etiquette and interpretive signs. Each should be standardised along the rail trail and, where appropriate, compliant with relevant local or Australian ‘standards’ or practices. The chosen colours of all signs should be uniform throughout the trail.

Themes and styles already established for other rail trails in Australia, and in keeping with the uniformity in signage sought by Railtrails Australia, may dictate what style of signs and marker posts are used along this rail trail. Trail markers and signage on other rail trails are sometimes affixed to old (recycled) railway sleepers or recycled plastic posts. There is a need for signage to be consistent with existing signage on the Links Mobility Corridor – where this signage is appropriate.

#### 3.7.1 DISTANCE SIGNAGE

Recognising that users will join a rail trail at any number of points, installing distance and direction signs at road crossings will not only benefit those joining the rail trail at that location, but provide additional information for users already on the rail trail. The plate should indicate the distance to the upcoming road crossings along the rail trail.



*Above left: Distance marker near road crossing on Railway Reserves Heritage Trail in Mundaring, Western Australia.*

*Above right: A distance marker is installed every mile along the Row River Rail Trail in Oregon, USA, together with a plaque indicating the responsible Adopt-a-Trail volunteer.*

Trail distance signage will need to be placed at regular intervals along the route. The obvious location is at each road crossing (and at the trailhead) where trail users are likely to join the trail. It is recommended that distance marker posts (together with Emergency Management GPS markers – see 3.7.2) be installed every 1 km.

The recommended distance sign plates (as with all other signs) should be affixed with at least 4 stainless security screws to prevent them being removed. In addition, the distance signs (as well as the various other sign panels used on the posts) should be affixed with silastic or 'liquid nail' products.



### 3.7.2 EMERGENCY MANAGEMENT SIGNAGE

---

Distance signage provides good reference points for emergency services. It gives anyone who needs emergency assistance an easy reference point. On other projects, consultation with ambulance officers in particular highlighted this need. When people panic (as they often do in an emergency situation), normal cognitive processes do not work. On-trail signage should be as helpful as possible and minimise likely stress. Consequently, distance signs should be installed at regular intervals, with distances to the next trailhead or major town or road crossing (on either side of the post). This enables people to quickly identify where they are by travelling a very short distance from the emergency situation. All road crossings should also have a GPS reference/identifier on the chicane (or on a separate post) for use in emergencies, again as a location aid for those in stress. There is also a need to include the emergency telephone number at all trailheads (on the trailhead map panel) and clearly identify that one number will contact all three emergency services (police, ambulance, fire). While the emergency number from a landline is 000, the emergency number that works best from a mobile phone is 112. Information on what to do in an emergency, the location of public phones (there may be none on the trail itself), and the capacity for a flip-down sign indicating trail closure (due primarily to fire, flooding or maintenance work) should also be included at each trailhead.

It is strongly recommended that "Emergency Markers" be installed along the Mary to Bay Rail Trail. The works tables (Section 4) have included these markers within the trail distance signage as has been done on the Kilkivan Kingaroy Rail Trail in Queensland and the Lilydale Warburton Rail Trail in Victoria.

In summary, the emergency signage that should be erected on a trail consists of:

-  Distance signs at regular intervals showing distances to next trailhead or town or road crossing (double-sided). It is recommended that these include emergency marker signs (with a series of unique codes or identifiers);
-  GPS identifiers at all road crossings (attached to the sign posts or gating systems); and
-  Trailhead signage specifying what to do in an emergency, the numbers to call, the location of public phones, and the capacity for a flip-down sign indicating trail closure (due primarily to fire, flooding or maintenance work).



*Above left: An Emergency Marker sign on the Lilydale Warburton Rail Trail in Victoria. Above right: An Emergency Marker on the Kilkivan Kingaroy Rail Trail in Queensland. Post also has distance plates.*

### 3.7.3 WARNING SIGNAGE

There are a number of locations along the proposed Mary to Bay Rail Trail that demand warning signage, primarily at the many road crossings facing trail users. In the case of road crossings, (either or both) a “Road Ahead” yellow diamond warning sign (W6-8A) some 50-70 metres before a crossing is recommended (on a stand-alone post), with a triangular “Give Way” sign (R1-2) on the verge at the road crossing (on a stand-alone post) – or a “Stop” sign where appropriate (R1-1 – 300 x 300). Bicycle/pedestrian (i.e. Trail Crossing) warning signs (W6-9) with arrow (W8-23) (or W6-V105) are recommended for installation on roads, either side of a trail crossing, or use of “Crossing Ahead” signs as indicated below.

The proposed rail trail has 5 road crossings along the route, and some of these provide both challenges and opportunities for trail development. The challenges come in ensuring that these crossings are safe for future trail users, while the opportunities surround the passing road users who can be alerted to the trail’s presence. Such ‘opportunistic’ promotion can only be good for the future of the rail trail in raising awareness and increasing user numbers.

### 3.7.4 PROMOTIONAL SIGNAGE

Promotional signage has been used to great effect on other rail trails throughout Australia, increasing general awareness of the trail among the broader community. For the proposed Mary to Bay Rail Trail, the recommended ‘promotional’ sign should be incorporated into the on-road ‘Crossing Ahead’ warning signs (such as has occurred on the Forrest Birregurra Tiger Rail Trail). They are an excellent means of communicating the message to road users that they need to be alert for the presence of cyclists and pedestrians.



*Above: Signage for the Tiger Rail Trail in Victoria warns of the upcoming road crossing as well as promoting its existence to road users. Right: different signs may need to be used, depending on trail user groups being permitted on the proposed trail.*

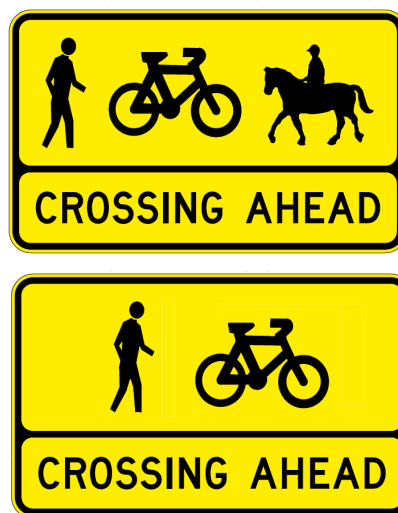

Though the railway corridor may be quite likely familiar to many local residents, it is recommended that a number of “Trailhead” signs also be erected to give prominence to the trail when constructed. The installation of these signs will enable local people and visitors become more aware of the trail (a good example is the High Country Rail Trail).

### 3.7.5 PERMITTED USER SIGNAGE

Signs (in the form of pictograms) indicating user groups that are permitted (or not permitted) on the various sections of the Mary to Bay Rail Trail should be installed at every road crossing and entry point. These small signs can easily be installed on the totem posts near to the proposed trail user access gates (chicanes) or even on the gates/chicanes themselves. Pictogram signage could include “No Motor Vehicles”, “No Motor Bikes”, “No Smoking”, “No Alcohol” and “Dogs on Lead” (or “No Dogs”). The installation of “No Motor Vehicles” and “No Motor Bikes” are recommended at the outset, and the trail manager will ultimately determine what other signage may be required.





*Signs pointing in to the “Trailhead”, as used on the High Country Rail Trail in Victoria, are an excellent means of directing trail users to a Trailhead and serve to promote the existence of the rail trail to passing motorists, tourists and local people.*



*Pictogram signs, as used extensively on other trails, can have a major impact by discouraging illegal users and activity.*

### 3.7.6 INTERPRETIVE SIGNAGE

On-trail interpretation is becoming more and more of a feature of trails built in recent times. When well done, it can add significantly to the depth of the user’s experience. It can also generate a sizeable cost and can be subject to ongoing vandalism in urban and rural areas.

All rail corridors are inevitably rich with history, not just European settlement history but also indigenous and natural history. The Mary to Bay Rail Trail corridor is no different. People will move along this trail at a leisurely pace. This slower rate of travel, a more relaxed frame of mind and openness to new experiences provide ideal circumstances to educate trail users on all aspects of the country through which they pass. There are many stories that can be told along rail trails. The provision of interpretive material will greatly enrich the experience of visitors to the rail trail.

Effective interpretive material gives a specific “flavour” of the events, landforms, wildlife, vegetation and agricultural activities relevant to a specific site. The intention is for the traveller to develop a deeper understanding of the multitude of stories contained in a region. Conversely, the themes can be designed to spark interest, encouraging people to explore any

story that interests them. It may also encourage them to extend their stay in the region to further pursue an interesting story or theme.

Interpretive signage does not need to be in place from the trail opening (though this would be a commendable outcome) but at least some information should be embodied in the trail brochure. Interpretation should be an integral part of any trail's development process.

The works tables make allowance for the placement of a number of panels along the rail trail.

---

### 3.8 EROSION CONTROL

Proper drainage is of considerable importance in constructing a lasting, maintenance-free trail. Water should be removed from trail surfaces as fast as possible, wherever possible. Given the flat terrain or gentle slopes involved on much of the proposed rail trail, erosion control should be relatively easy. As the railway has not operated for many years, maintenance of the formation and its drainage structures has been non-existent. Consequently, many of the culverts under the formation and drains along the formation have become overgrown with weeds, grasses and other vegetation. Most require cleaning out.

Those sections of the railway formation which do have blocked culverts or dysfunctional drains should be attended to in the trail construction process, as allowing water to stand on the proposed trail surface or run down even a gentle slope is to invite surface damage followed by costly repairs.

It may be necessary to clear existing drains on a regular basis, or to install additional culverts under the trail in some locations to remove standing water effectively – if this is done, care must be taken to ensure the surface is soundly patched afterwards.

While the cuttings appear to be in good condition, it may be necessary to build up the trail within the cuttings to ensure the cess (or side) drains operate effectively. It may be more effective to “build up” the trail formation to 300mm (rather than 150mm) rather than excavating the cess drains in cuttings – this can be determined at the time of construction. Sealing the trail (rather than providing a compacted earth surface) may present its own solutions to this particular issue.

---

### 3.9 BRIDGES

Bridges are one of the most obvious reminders of the heritage value of disused railways. They are also one of the most significant attractions of trails along disused railways and one of the costliest items in the development of trails on former railways.

There are a number of existing bridges that can be re-purposed as rail trail bridges, needing only to be suitable to carry pedestrians, bike riders and horses. Field examination showed that,

with one exception, all the bridges (both existing and proposed) have either “go-around” opportunities or the trail can easily be accessed from an adjoining road crossing meaning that bridges need not be developed to carry vehicles. The only exception is the trail between Quarry St and Aldershot. There are two bridges proposed for this trail section, meaning that if neither bridge can carry a vehicle the middle section (between the two bridges) will be isolated. It is proposed that the new bridge over Dead Man’s Gully be built to carry vehicles (it is the shorter of the two bridges). This will affect the costs; costings have been developed based on all bridges (with the exception of Dead Man’s Gully) not needing to carry vehicles.



*Above: although several of the old timber bridges remain intact, and can easily be refurbished for trail use, other bridges will require more substantial work. This adds considerably to the cost of developing the trail, but it is what trail users will expect to experience on the rail trail.*

### 3.9.2 EXISTING BRIDGES

---

Fieldwork for this Trail Development Plan found 14 locations where bridges are (or were) in place - most remain (in addition, two bridges would have been on the original railway formation south of Aldershot). Fraser Coast Regional Council re-used two existing timber bridges on the trail between Piggford Lane and Walligan trailhead. It is recommended (and costed) that the same approach be taken here. Where bridges remain, they should be re-used. Where bridges do not remain, a simple option at these locations is to install pre-fabricated bridges. Landmark is one company that specialises in supplying such bridges but there are other suppliers. The Council may be able to negotiate a reasonable rate on these bridges given the number needed and the relatively simple process of installation (none of the locations are particularly difficult working environments). These locations all have some remnants of the old crossings – notably concrete abutments and these are in varying condition. These may need to be cleared away although the Cardno report suggests that some could be re-used (*Cardno (2010) Mary to the Bay Rail Trail. Engineering Feasibility Report*).

Handrails will be required where the fall from the bridge decking to the ground is greater than 1 metre (this applies to all sites where pre-fabricated bridges have been recommended). This is



a Standards Australia requirement. Handrails will help ensure the safety of users of the bridges, preventing people from falling over the sides and giving a sense of safety, uniformity and consistency along the trail.

There are designated standards for handrails for pedestrians and cyclists (1.0 – 1.1m high for walkers and 1.3m for cyclists with a number of detailed specifications regarding design).

The works tables also recommend the construction of a pedestrian/cyclist bridge over Rocky Street in Maryborough (to parallel the existing rail bridge) as the best option at this location. This may be a pre-fabricated bridge though height may be an issue (although pre-fabricated bridges are used at a range of heights).

### 3.10 TRAIL FURNITURE

There are a number of scenic locations along the corridor well suited to the placement of seats that would benefit all trail users. An allowance has been made for the eventual installation of seats – at sites selected by the trail manager. Sites should have views over the adjoining countryside and the various bushland sites. Care should be taken in the selection of styles of seating and tables. Many styles commonly used on trails are more suited to backyard gardens, or city parks. Few look ‘right’ in the natural environment.

Placement of simply constructed seats at intervals along the trail will benefit all trail users.

### 3.11 TRAILHEADS AND PARKING

A trailhead is usually defined by the existence of a car parking area, often with picnic facilities, interpretive signage, a map panel of the trail showing sites of interest and distances to features along the trail and a Code of Conduct. It is a location where a (short or long) trail walk or ride can begin or end.

The most logical trailhead locations have been chosen for the major trailheads (or trail termini) - being Maryborough (at Alan and June Brown Carpark), and Maryborough West (in particular for horse riders heading towards Hervey Bay). Other (minor) trailheads have been recommended, to enable potential users to undertake shorter trail experiences. These other



*A typical trailhead interpretive shelter. Usually these shelters may contain two information panels (front and back, incorporating general information, a map with the trail route and key features and important safety information for trail users.*





trailheads are located at Churchill Mine Road, and Takura. A minor trailhead is also proposed for Aldershot; this is some distance from the trail itself and will be accessed via the signed road network. Some minor improvements are suggested for Walligan trailhead (which already exists). Basic facilities such as parking, and a picnic table or seats in the shade, interpretive information (on a map panel) showing distances to features along the rail trail is important and will prove useful to all rail trail users.

A concept plan for each trailhead is included in Appendix 3 of this Trail Development Plan.

### 3.12 CONSIDERATION OF INTENSIVE AGRICULTURAL ISSUES/PRACTICES

The proposed trail route (which included the disused railway line, road reserves and the former disused railway corridor) passes by at least one intensive agricultural activity - a sugar cane plantation south of Saltwater Creek. On previous projects, consultation with adjoining landowners has highlighted the need to put in place measures to ensure the safety of trail users and measures to ensure that the biosecurity of such farms is maintained.

In respect of cane harvesting, of particular concern to adjoining landowners (as expressed on similar jobs) are the following issues:

-  **The possibility of billets from cane harvesters during harvesting hitting trail users.** The need for physical barriers such as chain mesh fencing to contain the billets to the property (and to prevent them being sprayed onto the public land) has been considered. Signage at gates (see below) warning trail users not to enter the trail corridor while a harvester is running close to the corridor is recommended. (Warnings/advice should also occur on all trail “literature” – brochures, trailhead signage, etc - to reflect this situation).
-  **The possible dangers involved when crops are being sprayed** and the potential for spray drift across the trail. (Warnings/advice should also occur on all trail “literature” – brochures, trailhead signage, etc - to reflect this situation). Temporary signs would need to be erected at certain times (by the farmer) – especially when spraying insecticides and fertilisers. CSIRO has prepared a report *Spray Drift Management - Principles, Strategies and Supporting Information* to educate farmers on best practices.
-  **The possible dangers to trail users from water/irrigation drift**, especially the large volume from large sprinklers (not being contained to the farmland). Some farmers mentioned that irrigation sprinklers do emit high volumes of water at high speed and shifting wind patterns during irrigation can cause “water drift” potentially creating a hazard to human safety given the volume and speed of water. Promotion should occur on all trail “literature” to advise of this activity. Signs on gates should make

users aware of this activity. Trail users should also be warned via trail literature to stop when they see this type of activity impacting on the trail corridor.

- ✚ **Dust can be an issue during dry weather**, especially when large machines are moving close to **the** trail corridor. Landowners indicated that agricultural activities, particularly at harvesting, creates a lot of dust and limits visibility. The dust may lead to users not seeing machinery. (Warnings / advice should also occur on all trail “literature” – brochures, trailhead signage, etc - to reflect this situation). Temporary signs would need to be erected at certain times (by the farmer).

With good design, and adequate signage and adherence to good farming protocols, conflict and safety issues can be avoided when it comes to interactions between trail users and agricultural activities.

---

### 3.13 FENCING

Fencing along the proposed rail trail will either serve specific or general purposes. The two specific purposes of fencing are:

- ✚ To maximise safety when the trail is constructed alongside (and within) an infrequently operating, low speed rail corridor (between Maryborough Trailhead and Maryborough West Trailhead); and
- ✚ To maximise safety when the trail is constructed alongside (but not within) an active rail corridor (between Saltwater Creek and Colton siding).









The Feasibility Study recommended that the route for the proposed rail trail through Maryborough utilise the existing (active) railway corridor. The corridor has ample width for the alignment of a pathway/trail. Throughout Australia, and elsewhere in the world, shared paths have been constructed alongside operating railways without complications. Even though the railway corridor through Maryborough serves only a handful of trains (at very slow speeds) each week, and it is not electrified, barrier fencing would be required to provide added safety and to prevent trespass. VicTrack provide some guidance for design for shared user pathways on VicTrack land (*Shared User Pathways on VicTrack Land: Design Guidelines for Applicants. June 2009*). In respect of fencing, the shared user pathway is required to be fenced on the trackside. The fence location is necessary due to safety regulations that also require the provision of gates in the rail corridor at regular intervals for track maintenance access.

The VicTrack guidelines note that fencing is to be installed for the purpose of exclusion of the public from areas requiring authorised access. Accordingly, all fencing shall be installed such that:

- ✚ Exclusion of persons is effectively achieved over the extent of the fence; and
- ✚ Gaps in fencing are minimised as far as practicable.

The fencing standard recommended in the VicTrack guidelines is that any shared user pathway is to be fenced full length trackside with 1.5m high non-climbable fence, weldmesh or equivalent fencing. In high risk areas (not defined in the guidelines), the fencing standard is to be 1.8 metre-high chain wire fencing to reduce safety risks and prevent trespasser access. In the absence of guidance on what constitutes high risk and noting that the Mary Ann replica locomotive operates without any safety fencing through Queens Park on a regular basis, it is recommended that the 1.5 m height be adopted for fencing between Maryborough Trailhead and Walker Street underpass and the 1.8 m standard be adopted for fencing along Road 21 between Aldershot and Colton (as is currently in place separating Bronze Street and the active railway line at Aldershot).

Fencing along a rail trail is required for several general reasons:

-  To prevent unauthorised access onto the rail trail;
-  To prevent authorised trail users (cyclists, walkers) from attaining access onto adjoining properties, and to prevent unauthorised trail users (trail bikes, etc.) from illegally trespassing onto private property;
-  To minimise disturbance of stock by trail users;
-  To prevent encroachments by adjoining landowners;
-  To delineate freehold (private property) from Crown land and to minimise encroachments and trespassing, unintended or otherwise;
-  To ensure the safety of trail users during harvesting in particular;
-  To prevent stock from straying (recognising that it is the land owner's responsibility to ensure stock does not stray); and
-  To keep stock off the rail trail and away from trail users.

Preventing stock accessing the corridor is not a significant issue on this corridor with the exception of the proposed new trail between Colton siding and Aldershot. The landholder in this locality has stock grazing up to the active railway line. Fencing will be required in this location to ensure stock do not access the trail corridor (post and 4 strand barbed wire fencing is the accepted style - the landholder in question has accepted this).

---

### 3.14 MACHINERY AND STOCK CROSSINGS

The rail corridor (and hence the trail) rarely passes “between” properties i.e. in locations where a landholder utilises both sides of the corridor and moves stock and machinery across the corridor. Between Saltwater Creek and Quarry Rd, the trail is proposed to run alongside an operating cane farm, but it is understood that the properties on both sides are in different ownership and machinery is not moved across the corridor. There are no other locations where

it is obvious that landholders utilise the corridor, and no landholders identified themselves as using or crossing the corridor in the course of consultation.

The following advice is provided of a general nature in case landholders in this situation make themselves known to Council if the trail proceeds.

Machinery and stock crossing facilities are generally required where landholders' own parcels on both sides of the corridor. Such crossings can be either 'open' meaning that machinery/stock are able to cross the rail trail to the other side of the corridor at all times, unhindered by gates – with trail users having to open gates to get across the crossing, or they can be gated either side of the corridor meaning that the adjoining landowners would be responsible for opening the gates when needed.

By having 'open' crossings, machinery can have unrestricted access. In this scenario, trail users will need to open self-closing gates at each side of the crossing and pass across from one side to the other. The gates need to be 1200mm spring-loaded gates opening into the crossing in order to prevent stock pushing them open. Gate design needs to ensure that the gate closes against the adjoining fence post (i.e. the opening for the gate is to be less than 1200mm). While not favoured by rail trail users as this is somewhat inconvenient (especially when there are many gates to open/close) it is regarded as one of the best compromise designs. By allowing machinery and/or stock from adjoining farms to cross from one side of the corridor to the other at all times, the interruption to current farming practices is minimised and adjoining landowners are much more favourably disposed to the prospect of the rail trail.

Individual discussions with landholders at the time of construction would work out the most appropriate system.

A concreted crossing point of the rail trail surface at each 'machinery crossing' is strongly recommended to ensure the regular passage of machinery and stock across the rail trail does minimal damage to the trail surface and is long-lasting.



---

### 3.15 ENCROACHMENTS IN THE TRAIL CORRIDOR

Between the closure of the railway in 1993 and the present, at least one encroachment on to the former railway corridor have been made. An access road or driveway appears to have been built on the railway formation at Takura.

The practical difficulties associated with developing a trail where there are longstanding encroachments are appreciated, given that this use of the corridor is probably longstanding. It is typical of most abandoned railway corridors that neighbouring landowners take advantage of the available (public) land when there seems no other use.

However, it is not desirable to pursue a course that takes the trail off the railway corridor to avoid these encroachments (a trail can be developed/located within the railway corridor but not on the old formation). In this particular instance, it is proposed that this section of the trail be retained on the road access (it is likely to have very low vehicular use) and that interactions be managed by signage.

The other major encroachment on the corridor is the mining lease at Colton – this has been discussed extensively in Section 3.2.

---

### 3.16 OTHER USERS AND TRAIL ETIQUETTE

Managing interaction between user groups is a primary prerequisite on all trails, and standard signage and protocols already exist. Providing adequate signage is installed and users are well aware of the likelihood of meeting other user groups, such interactions should generally be non-threatening and relatively safe.

Every attempt must be made to ensure the rail trail is not used by either four-wheel drives or trail bikes, though this is likely to be difficult to manage and hard to police. The proposed management access gates and chicanes at every road crossing and either side of bridges between Churchill Mine Road and Walligan Trailhead will go part way to addressing this issue. Repairing fencing at obvious (illegal) cross over points (particularly between Churchill Mine Road and Takura) is the other critical works item.









Education through signage and use of gates or other vehicle exclusion barriers will help, as will encouraging bona-fide users – and local residents – to report registration numbers of illegal users.

---

### 3.17 CODES OF CONDUCT

A Code of Conduct for each user group provides all trail users with guidelines to minimise their impact on the environment, and on other trail users.

Codes of Conduct help to:

-  Prevent trespass;
-  Prevent soil erosion;
-  Minimise trampling;
-  Prevent the introduction and spread of noxious and exotic plants;
-  Protect waterways;
-  Reduce the risk of fire;
-  Protect significant and environmentally sensitive sites;
-  Minimise potential conflict with other users of the trail;
- and
-  Ensure the safety of all trail users.



*The Murray to the Mountains Rail Trail has a Code of Conduct sign board at regular intervals along the trail ensuring that all trail users are aware of their rights and responsibilities.*

Trailhead signage is the best place to provide Code of Conduct signage.

### 3.18 HERITAGE ISSUES

A number of structures along any railway corridor have historical or heritage value. These include station buildings, station signs, bridges, culverts, cuttings and embankments, and distance posts. A rail trail will enhance the appreciation of these historic assets.





However, most such structures and items have been removed. However, it is understood that many of the railway artefacts remain within the wider community (including at Council depots) and some of these may be available for reinstatement on the rail trail.

It is strongly recommended that the trail manager seek to ensure as many artefacts and relics of the railway are put back in place once the trail is constructed.

It is hoped that station/siding name boards can be returned (or replicated) to each siding location as part of the interpretation of that site.

### 3.19 ENVIRONMENTAL ISSUES

A number of key environmental issues have been identified. These include:



-  Clearing of regrowth vegetation along the corridor, and the need for clearing permits and the possible future need for offset re-vegetation.
-  The potential for the spread of weeds (and pathogens) during the construction phase and, potentially, through usage of the trail.
-  Contamination of soils as a result of the operations of the railway and the manner in which former bridges were constructed and maintained.
-  The potential for sedimentation of watercourses as a result of trail construction and bridge works.

In addition, care will need to be taken in the ongoing maintenance of the proposed rail trail to ensure weeds and pathogens are not unwittingly spread by maintenance machinery. Ongoing clearing at the sides of the rail trail will be required to keep the trail corridor at acceptable widths.

### 3.20 CLEARING FOR THE RAIL TRAIL

In the years since the railway last operated, vegetation (in various forms) has regrown along parts of the corridor that formerly was kept clear of vegetation. The amount of regrowth vegetation varies markedly along the corridor.

Three types of clearing have been identified along the length of the corridor. These are:

-  Minor clearing of vegetation required (only top soil needs removal and/or slashing prior to earthworks).
-  Moderate clearing of vegetation (some regrowth in trail corridor).
-  Heavy clearing of vegetation (substantial regrowth in trail corridor and/or thick undergrowth).

The estimates of probable costs reflect these various types of clearing of vegetation.

Generally speaking, a cleared 'trail corridor' of 3.5 - 4.0 metres will be required to enable a trail of 2.5 metres to be developed in the centre of the cleared corridor. Either side of this trail will be further clearing of vegetation up to 1.0m for drainage.

Ongoing maintenance will be required, on an 'as and when required' basis, to prune the vegetation alongside the trail to keep the trail corridor clear of overhanging vegetation. The regularity of the clearing of side growth vegetation will depend on numerous factors, particularly the type of vegetation growing alongside the trail over its length.

---

### 3.21 TOILETS

The proposed trailhead at Maryborough has easy access to existing toilets as does the existing trail between Urangan and Nikenbah. Consideration has been given to the installation of additional toilets along the rail trail but it is felt unnecessary given the relatively short distances between the existing facilities and the high cost of new toilets. There is no standard accepted distance between toilets on a trail.

---

### 3.22 CABLES AND OTHER UTILITIES

Fieldwork revealed the existence of utilities (telecom cabling etc) within the corridor. Cable locators will be required to establish the precise locations of utilities and services prior to construction activity occurring. This will be a major issue in Maryborough along the existing railway line and will also need critical analysis during planning of the underpass of Maryborough Hervey Bay Road.



## SECTION 4 – WORKS LISTS AND PROBABLE COSTS



### 4.1 INTRODUCTION

Investigations undertaken during the fieldwork associated with this project enable a reasonably accurate picture of the work required to bring about the development of a rail trail within the disused railway corridor between Maryborough and Walligan Trailhead.

### 4.2 LANDHOLDER CONSULTATION

Adjoining landholders were invited to meet with the consultants during fieldwork to discuss issues and possible solutions. Four landholders took advantage of the opportunity although only two wanted to discuss issues and solutions (the other two were seeking or providing clarification).

Issues raised covered:

-  Retaining existing access across the corridor for machinery in particular (where a landholder uses both sides of the corridor); and
-  Retaining a grazing opportunity.

Landholder requests are identified in the works tables. There are also works items added in where landholders have not formally requested consultation, but experience suggests solutions will be needed (this is particularly the case south of Saltwater Creek on land owned by Fraser Coast Regional Council).

There is an additional allowance in each section for additional landholder requests that may emerge as the project proceeds.

It should be noted that the works items recommended reflect the farming practices in place at the time of report preparation. It may be that the farming practice will change between the report finalisation and trail construction (should it proceed).

### 4.3 ADDITIONAL NOTES

The following notes are relevant when reading Tables 1 to 6:

-  Map references shown in the tables refer to works items shown on the Plans in Appendix 5.
  - Plan 1 covers the section from Maryborough Trailhead to Maryborough West Trailhead.
  - Plan 2 covers the section from Maryborough West Trailhead to Quarry Road.
  - Plan 3 covers the section from Quarry Road to Colton siding.

- Plan 4 covers the section from Colton siding to Churchill Mine Road Trailhead.
- Plan 5 covers the section from Churchill Mine Road Trailhead to Walligan Trailhead (at Dundowran Road – the end of the existing smaller trail).
- Plan 6 covers the section from Piggford Lane to Nikenbah (the end of the existing Links Mobility Corridor).



Works items shown on maps are generally in the precise location (though measurements may vary slightly on the ground).

#### 4.4 WORKS TABLES

**Table 1: Maryborough to Maryborough West Trailhead (4.3km) (refer Plan 1 in Appendix 5)**

Works Item #	GPS Reference	Works Item	\$
1	S 25° 32.199' E 152° 42.025'	Maryborough Trailhead (Alan and June Brown Carpark) (See Trailhead plan – Appendix 3). <ul style="list-style-type: none"> <li>• Install double-sided trailhead sign (brown chevron) on southern corner of Kent St and carpark entry (\$1,600).</li> <li>• Install Trail Directional Marker (2) (\$1,200).</li> <li>• Install Trailhead map panel (\$5,500).</li> </ul>	8,300
2	S 25° 32.180' E 152° 42.003'	Trail to use existing concrete footpath across railway line on Kent St. Trail turns west to run on northern side of existing railway line (place Trail Directional Marker as per Trailhead drawing).	0
3	S 25° 32.180' E 152° 42.003'	Construct new sealed trail between Kent Street and Maryborough West Trailhead (4,385 m). Construction includes stripping of top soil, boxing out, compacting subgrade (to 150mm), filling with road base, levelling, trimming, shaping, compacting and sealing.	986,625
4	S 25° 32.180' E 152° 42.003'	Clearing between Kent Street and Maryborough West Trailhead. Allow slashing/side clearing (3,585 m). Allow moderate clearing from pedestrian maze adjacent to animal refuge to Maryborough West Trailhead (800 m).	10,980

5		Install 1.5 m chain mesh fencing along corridor between Kent Street and Maryborough West Trailhead to separate trail users from infrequent low speed train movements (4,385 m).	219,250
6	S 25° 32.134' E 152° 41.795'	Trail to cross from northern side of railway line to southern side (at existing points beyond the separation of railway line). Construct crossing maze and install pipe and fill under trail.	9,000
7	S 25° 32.000' E 152° 41.763'	Normanby St. existing pedestrian overpass. Create access on southern side from street. Install pedestrian/cycle user gate and management access gate in existing fence (south side of corridor) to allow trail users and management vehicles from Tooley St to access trail. (Council may wish to install access gates at other locations along the trail to get better use by local pedestrians and cyclists – noting that one access point already exists at Morning Street. Additional access points have not been included).	3,000
8	S 25° 31.920' E 152° 41.584'	Trail goes under Pallas St. Trail is to stay within corridor. Build 25 m deck (using composite materials) over existing open concrete v-drain to get under bridge. Deck to be at same level as concrete footing under bridge. Deck will be approximately 2 m wide.	20,000
9	S 25° 31.794' E 152° 41.420'	Rocky St. The recommended option is a 20 metre pre-fabricated bridge alongside the existing railway bridge. The alternative option involves taking the trail off the railway corridor at the Cheapside St crossing, constructing it in the drainage reserve that runs from Cheapside St to Rocky St, crossing over Rocky Street opposite the entrance to the Ergon depot, using the drainage easement (existing drain) and the Ergon access way and other Ergon land to construct a ramp back to the railway corridor 10-20 metres west of the railway bridge. On the eastern side of Rocky Street, the property	100,000

		boundary is too narrow to provide a trail back to the railway formation immediately east of the bridge hence the use of the drainage reserve. (Costings are similar but the less preferred option requires negotiation with Ergon for access).	
10	S 25° 31.485' E 152° 41.004'	Reconfigure at-grade crossings at Morning St to allow trail access.	5,000
11	S 25° 31.335' E 152° 40.801'	Trail at Russell St to use existing railway corridor. Clearance is 3 metres from the side of the existing rail formation to the retaining wall. (trail to be built at 2 m wide under bridge). Install pipe under trail to retain drainage through cutting.  Road reserve on southern side of railway corridor could be used but this option would cost more and would involve dealing with encroachments on road reserve on western side of Russell St.	2,000  Trail construction covered in WI 3
12	S 25° 31.139' E 152° 40.506'	Install maze crossing on road reserve (Palmer St) across railway line immediately south of animal refuge.	7,500
13	S 25° 31.130' E 152° 40.509'	Trail to run along edge of existing bush land next to railway corridor. Minimise clearing (trail on Kent St road reserve). Erect 1.5 m chain mesh fencing on eastern side of trail between trail and railway line.	0 (Costed in WI 3 and 4; Fencing costed in WI 5)
14	S 25° 30.902' E 152° 40.640'	Underpass at Walker St. Install pipe under trail to retain drainage through cutting.	2,000
15	S 25° 30.888' E 152° 40.630'	Construct new trail to connect Walker St underpass to Maryborough West trailhead (120m). (Trail not on railway corridor – see trailhead plan - Appendix 3).	0 (Costed in WI 3 and 4)
16	S 25° 30.854' E 152° 40.536'	Maryborough West Trailhead (See Trailhead plan – Appendix 3). <ul style="list-style-type: none"><li>Install double-sided trailhead sign (brown chevron) on Walker St (\$1,600).</li></ul>	12,400



<ul style="list-style-type: none"> <li>• Install double-sided trailhead sign (brown chevron) on Slaughterhouse Rd (\$1,600).</li> <li>• Install “trail crossing” signs on both sides of trail on Slaughterhouse Rd (\$1,200).</li> <li>• Install Trail Directional Marker (2) (\$1,200).</li> <li>• Install “Give Way” signs on trail on both sides of road (\$400).</li> <li>• Install “Road ahead” signs on trail on both sides of Slaughterhouse Rd (\$400) (only 1 shown on drawing)</li> <li>• Install Trailhead map panel (\$5,500).</li> <li>• Install horse hitching rails (\$500).</li> </ul>	
Allowance for 6 management access gates in separation fence between Maryborough Trailhead and Maryborough West trailhead to allow access onto rail line at locations to be determined in consultation with rail manager.	6,000
Allowance for additional landowner requests (e.g. fencing and vegetation screening).	0
Allowance for installation of additional interpretive signage (at locations to be determined by trail manager and local historians) (2 signs).	6,000
Allowance for Trail Directional Markers (incorporating emergency markers) to be placed along trail every 1 km.	2,400
Allowance for installation of trailside furniture (e.g. seats) at locations to be determined by trail manager (3 units).	6,000
Allowance for marking trees to be cleared, pruned or left untouched (in the vicinity of the animal refuge).	1,200
Allowance for marking centreline of trail with flagging tape prior to clearing and construction.	3,600

Allowance for purchase and installation of:	1,200
<ul style="list-style-type: none"> <li>• Regulatory signage (Shared Path; “No Trail Bikes”; “Authorised Users Only”);</li> <li>• Road name signs;</li> <li>• Trail name signs;</li> <li>• “No Trespassing” signs;</li> <li>• Local attractions sign; and</li> <li>• Miscellaneous signs (Keep Out etc.).</li> </ul>	
Allowance for traffic management (2 locations where construction will be around road crossings).	4,000
Allowance for cable locators along the existing railway corridor.	10,000
Allowance for solar lighting	450,000 (cost supplied by FCRC)
<i>Sub-total</i>	<i>\$1,876,455</i>
Approvals, permits, applications, designs, specifications, assessments (2.5% of \$1,876,455).	46,910
Contingency amount (20% of \$1,876,455).	375,290
Project management (5% of \$1,876,455).	93,820
<b><i>TOTAL (NOT INCLUDING GST)</i></b>	<b><i>\$2,392,475</i></b>

Table 2: Maryborough West Trailhead to Quarry Road (2.9km) (refer Plan 2 in Appendix 5)

Works Item #	GPS Reference	Works Item	\$
		Maryborough West Trailhead (see Table 1).	0
1	S 25° 30.830' E 152° 40.550'	Construct new trail (on grassy verge on western side of Slaughterhouse Rd) between Maryborough West Trailhead and WI 3 (490 m). Construction includes stripping of top soil, boxing out, compacting subgrade (to 150mm), filling with road base, levelling, trimming, shaping and compacting.	39,200
2		Clearing between Maryborough West Trailhead and Quarry Rd (2,900 m). Allow heavy clearing of trees (870 m). Allow minor clearing (490 m). Allow moderate clearing along remainder (1,540 m).	24,430
3	S 25° 30.599' E 152° 40.515'	Trail rejoins railway formation. Remove bunding to create trail. Install Trail Directional Markers (2) on east and western side of Slaughterhouse Rd. Allow for vehicle exit on northern side of QR depot. Separate access road from trail route with line of bollards running east-west south of trail route (20 metres).	3,260
4		Construct new trail on railway formation between WI 3 and Quarry Rd (2,410 m). Construction includes stripping of top soil, boxing out, cleaning side drains, compacting subgrade, filling with road base, levelling, trimming, shaping and compacting.	144,600
5		Allowance for slashing of parallel bridle trail (2,900 m). (slashing may not be needed depending on clearing work but horse trail needs to be differentiated from pedestrian/cyclist trail).	14,500
6	S 25° 30.016' E 152° 40.494'	Install trail user chicane and management gate system and 5 m fencing either side of gating system. Set gating system in cement stabilised gravel "apron" for ease of maintenance.	3,540

7	S 25° 29.881' E 152° 40.494'	Install trail user chicane and management gate system and 5 m fencing either side of gating system. Set gating system in cement stabilised gravel “apron” for ease of maintenance.	3,540
8	S 25° 29.454' E 152° 40.472'	Install trail user chicane and management gate system and 5 m fencing either side of gating system. Set gating system in cement stabilised gravel “apron” for ease of maintenance.	3,540
9	S 25° 29.390' E 152° 40.472'	Intersection of Quarry Rd and railway corridor. Trail to turn east. Install Trail Directional Marker.	600
		Allowance for additional landowner requests (e.g. fencing and vegetation screening).	0
		Allowance for installation of interpretive signage (at location to be determined by trail manager and local historians) (1 sign).	3,000
		Allowance for removal of cross fences.	1,500
		Allowance for cleaning of, and earthworks around, pipe and box culverts under railway embankment.	1,200
		Allowance for Trail Directional Markers (incorporating emergency markers) to be placed along trail every 1 km.	1,800
		Allowance for installation of trailside furniture (e.g. seats) at locations to be determined by trail manager (0 units).	0
		Allowance for marking trees to be cleared, pruned or left untouched.	1,200
		Allowance for marking centreline of trail with flagging tape prior to clearing and construction.	1,200



Allowance for purchase and installation of:	1,200
<ul style="list-style-type: none"> <li>• Regulatory signage (Shared Path; “No Trail Bikes”; “Authorised Users Only”);</li> <li>• Road name signs;</li> <li>• Trail name signs;</li> <li>• “No Trespassing” signs;</li> <li>• Local attractions sign; and</li> <li>• Miscellaneous signs (Keep Out etc.)</li> </ul>	
Allowance for traffic management (0 road crossings).	0
Allowance for cable locators at road crossings (0 road crossings).	0
<i>Sub-total</i>	<i>\$248,310</i>
Approvals, permits, applications, designs, specifications, assessments (2.5% of \$248,310).	6,210
Contingency amount (20% of \$248,310).	49,660
Project management (5% of \$248,310).	12,415
<b><i>TOTAL (NOT INCLUDING GST)</i></b>	<b><i>\$316,595</i></b>

Table 3: Quarry Road to Colton siding (7.7km) (refer Plan 3 in Appendix 5)

Works Item #	GPS Reference	Works Item	\$
		Intersection of Quarry Rd and railway corridor. Trail to turn east. (see Table 2).	0
1	S 25° 29.390' E 152° 40.472'	Construct new trail between Quarry Rd and WI 2 (70 m). Construction includes clearing and trail construction.	5,250
2	S 25° 29.392' E 152° 40.500'	Intersection of Quarry Rd (dead-end) and new trail to be built on FCRC land. Install Trail Directional Marker.	600
3		Newly constructed trail will run along boundary fence between old railway corridor (privately owned) and land owned by FCRC on the eastern side. Allowance for surveying the property line (2,475 m).	12,375
4		Construct of gravel trail 2.5 m wide compacted to 150mm between end of Quarry Rd and Saltwater Creek (2,475 m). Construction includes stripping of top soil, boxing out, filling, levelling, trimming, shaping and compacting gravel.	198,000
5		Allowance for slashing of parallel bridle trail (2,475 m). (horse trail needs to be differentiated from pedestrian/cyclist trail).	12,375
6		Slashing/side clearing between Quarry Rd and Saltwater Creek (2,475 m).	3,715
7	S 25° 29.392' E 152° 40.500'	Install spring-loaded user gate and management access gate and 3 m fencing perpendicular to direction of travel. Install warning signage regarding agricultural activity.	2,600
8	S 25° 29.392' E 152° 40.500'	Trail runs through farming land and cane fields.  Install post and wire fencing and signage on eastern side to minimise access (600 m).  Install 2.4 m high chain mesh barrier fencing and appropriate signage (on eastern side of trail) to deal with potential safety issue from	159,000

		<p>harvesting where trail runs past cane crops (1,875m). <i>Consultants' recommendation rather than landholder request.</i></p> <p><i>(An alternative lower cost option may be for FCRC to include a condition of lease to remove cane from within 30 metres of trail and use post and wire fencing similar to what exists on the western boundary).</i></p>	
9	S 25° 28.729' E 152° 40.358'	Construct new bridge over Dead Man's Gully (40 m). Bridge to carry light vehicles.	480,000
10	S 25° 28.151' E 152° 40.161'	Install spring-loaded user gate and management access gate and 3 m fencing perpendicular to direction of travel. Install warning signage regarding agricultural activity.	2,600
11	S 25° 28.111' E 152° 40.146'	Construct new 60 metre steel truss or cable suspension bridge over Saltwater Creek. Bridge to be constructed at same height as existing upstream railway bridge to deal with flooding. Bridge need not carry vehicles.	480,000
12	S 25° 28.111' E 152° 40.146'	<p>Northern bank of Saltwater Creek where bridge should land.</p> <p>Trail to proceed north to Bronze Street.</p> <p>Develop link between landing point and new trail on land owned by DTMR adjacent to active railway line. Access (5 m wide x 20 m long) may need to be acquired as DTMR land is very narrow at southern end.</p> <p>Construct trail on land owned by DTMR (210 m).</p> <p>Acquire or negotiate easement over 130 m of land for trail to connect to Bronze St.</p> <p>To minimise acquisition, build trail close to existing barrier fence (trail to be 5m width).</p>	12,000 (allowance for land acquisition and surveying)
13	S 25° 28.111' E 152° 40.146'	Construct gravel trail 2.5 m wide compacted to 150 mm thickness between Saltwater Creek and southern end of Bronze St (340 m). Construction includes stripping of top soil, boxing out, filling, levelling, trimming, shaping and compacting gravel.	27,200

14	S 25° 28.111' E 152° 40.146'	Allowance for slashing of parallel bridle trail (340 m) once trail envelope is cleared. (slashing may not be needed depending on clearing work but horse trail needs to be differentiated from pedestrian/cyclist trail).	1,700
15	S 25° 28.111' E 152° 40.146'	Allow heavy clearing of trees between Saltwater Creek and southern end of Bronze St (340 m).	4,760
16	S 25° 28.111' E 152° 40.146'	Erect post and wire fencing on eastern side of new trail between Saltwater Creek and southern end of Bronze St (340 m).  Install 1.8 m chain mesh fencing along corridor on western side to separate trail users from high speed train movements (340 m).	25,500
17	S 25° 27.949' E 152° 40.039'	Trail reaches Bronze Street.  Install pipe culvert under trail.  Install trail user chicane and management gate system and 2.5 m fencing either side of gating system (existing cross fence may be sufficient) and appropriate signage. Set gating system in cement stabilised gravel “apron” for ease of maintenance.  Install Trail Directional marker for users to head along Bronze St (cyclists on-road; pedestrians and horse riders on verge).	8,140
18	S 25° 27.823' E 152° 39.961'	Install Trail Directional Marker at corner of Bronze St and unnamed street crossing active railway line (on eastern side of Bronze St). <ul style="list-style-type: none"> <li>• <i>South face – Hervey Bay (straight ahead arrow), Aldershot (left turn arrow).</i></li> <li>• <i>West face – Hervey Bay (left turn arrow), Maryborough (right turn arrow).</i></li> <li>• <i>North face - Maryborough (straight ahead arrow), Aldershot (right turn arrow).</i></li> </ul>	600



<i>Start of Spur trail:</i>			
<i>Series of Trail Directional Markers to direct users to Aldershot trailhead</i>			
19	S 25° 27.843' E 152° 39.921'	Install Trail Directional Marker at corner of Shiplick St and unnamed street crossing active railway line (on western side of Shiplick St). <ul style="list-style-type: none"> <li>• <i>East face – Aldershot (right turn arrow).</i></li> <li>• <i>North face – Hervey Bay, Maryborough (left turn arrow).</i></li> </ul>	600
20	S 25° 27.756' E 152° 39.872'	Install Trail Directional Marker at corner of Shiplick St and Vaughan St (on eastern side of Shiplick St). <ul style="list-style-type: none"> <li>• <i>South face – Aldershot (left turn arrow).</i></li> <li>• <i>West face – Hervey Bay, Maryborough (right turn arrow).</i></li> </ul>	600
21	S 25° 27.860' E 152° 39.689'	Install Trail Directional Marker at corner of Vaughan St and Lenthall St (on south east corner). <ul style="list-style-type: none"> <li>• <i>East face – Aldershot (left turn arrow).</i></li> <li>• <i>South face – Hervey Bay, Maryborough (right turn arrow).</i></li> </ul>	600
22	S 25° 27.915' E 152° 39.723'	Install Trail Directional Marker at corner of Lenthall St and Murray St (on southern side of Murray St). <ul style="list-style-type: none"> <li>• <i>North face – Aldershot (right turn arrow).</i></li> <li>• <i>West face – Hervey Bay, Maryborough (left turn arrow).</i></li> </ul>	600
23	S 25° 27.944' E 152° 39.679'	Aldershot Trailhead (See Trailhead plan – Appendix 3). <ul style="list-style-type: none"> <li>• Install double-sided trailhead sign (\$1,600).</li> <li>• Install Trail Directional Marker (2) (\$1,200).</li> <li>• Install Trailhead map panel (\$5,500).</li> </ul>	8,300
<i>End of Spur trail:</i>			

24	S 25° 27.525' E 152° 39.776'	Construct small boardwalk (7 m) to connect from Bronze St (northern end) across significant drainage ditch to Road 21 road reserve. Install Trail Directional Marker on north side of boardwalk.	7,600
25	S 25° 27.520' E 152° 39.776'	Construct gravel trail 2.5 m wide compacted to 150mm thickness between end of Bronze St and Colton siding on Road 21 road reserve (not on rail formation) (3,950 m). Construction includes stripping of top soil, boxing out, filling, levelling, trimming, shaping and compacting gravel. Build trail close to existing barrier fence (trail needs a total of 5m width). Trail will need to deviate from line parallel to railway line on occasion to go around rail electrical boxes such as at S 25 ° 25.769' E 152 ° 39.203'	316,000
26		Allowance for slashing of parallel bridle trail (3,950 m) once trail envelope is cleared. (slashing may not be needed depending on clearing work but horse trail needs to be differentiated from pedestrian/cyclist trail).	19,750
27		Clearing for trail construction (3,950 m). Allow for heavy clearing of trees immediately north of Bronze Street (400 m). Allow for moderate clearing (1,000 m). Allow for light clearing (2,550 m).	20,250
28	S 25° 27.520' E 152° 39.776'	Erect post and wire fencing on eastern side of new trail between northern end of Bronze St and Colton siding (3,450 m).	51,750
29	S 25° 27.498' E 152° 39.753'	Boundary fence (between active railway line and road reserve) changes from 2.4 m chain mesh barrier fencing to 4 strand barbed wire fence. Install 1.8 m chain mesh fencing along corridor (3,890 m) on western side to separate trail users from high speed train movements (this may be unnecessary – there is an existing fence as noted but increasing the potential number of users alongside the rail line may necessitate building a higher fence).	233,400

30		Allowance for 4 drainage measures (pipe and fill over) between start of trail and S 25° 27.165' E 152° 39.635'.	8,000
31	S 25° 26.489' E 152° 39.530'	Remove locked gate.	200
32	S 25° 25.506' E 152° 39.092'	Original Colton Siding – reinstate siding nameboard.	2,000
		Allowance for additional landowner requests (e.g. fencing and vegetation screening).	5,000
		Allowance for installation of interpretive signage (at locations to be determined by trail manager and local historians) (2 signs).	6,000
		Allowance for Trail Directional Markers (incorporating emergency markers) to be placed along trail every 1 km.	4,800
		Allowance for installation of trailside furniture (e.g. seats) at locations to be determined by trail manager (3 units).	6,000
		Allowance for marking trees to be cleared, pruned or left untouched.	2,400
		Allowance for marking centreline of trail with flagging tape prior to clearing and construction.	3,600
		Allowance for purchase and installation of: <ul style="list-style-type: none"> <li>• Regulatory signage (Shared Path; “No Trail Bikes”; “Authorised Users Only”);</li> <li>• Road name signs;</li> <li>• Trail name signs;</li> <li>• “No Trespassing” signs;</li> <li>• Local attractions sign; and</li> <li>• Miscellaneous signs (Keep Out etc.).</li> </ul>	1,200
		Allowance for traffic management (2 road crossings in Aldershot).	4,000

Allowance for cable locators at road crossings (2 road crossings in Aldershot).	2,000
<i>Sub-total</i>	<i>\$2,141,065</i>
Approvals, permits, applications, designs, specifications, assessments (2.5% of \$2,141,065).	53,525
Contingency amount (20% of \$2,141,065).	428,210
Project management (5% of \$2,141,065).	107,055
<b><i>TOTAL (NOT INCLUDING GST)</i></b>	<b><i>\$2,729,855</i></b>

**Table 4: Colton Siding to Churchill Mine Road Trailhead (7.0km approximately) (refer Plan 4 in Appendix 5)**

Works Item #	GPS Reference	Works Item	\$
		Original Colton Siding (see Table 3)	0
1	S 25° 27.506' E 152° 39.092'	Construct gravel trail 2.5 m wide compacted to 150mm thickness between Colton siding and WI 5 (a point north of the siding on Road 21 road reserve) (1,500 m). Construction includes stripping of top soil, boxing out, filling, levelling, trimming, shaping and compacting gravel. Build trail close to existing barrier fence (trail needs a total of 5m width). (Existing management access track could be used for this purpose – this would reduce the costs).	120,000
2		Allow light clearing between Colton siding and WI 5 (1,500 m).	4,500
3		Allowance for slashing of parallel bridle trail (1,500 m). (horse trail needs to be differentiated from pedestrian/cyclist trail).	7,500
4	S 25° 27.506' E 152° 39.092'	Erect post and wire fencing on eastern side of new trail between Colton siding and WI 5 (1,500 m).  Install 1.8 m chain mesh fencing along corridor on western side between Colton siding and WI 4 to separate trail users from high speed train movements (1,500 m).	112,500
5	S 25° 24.761' E 152° 38.764'	This point appears to be beyond the north western edge of the mining lease. New trail to turn east towards Churchill Mine Rd Trailhead.  Install Trail Directional Marker. <ul style="list-style-type: none"> <li>• <i>South face – Hervey Bay (right turn arrow)</i></li> <li>• <i>East face – Maryborough (left turn arrow)</i></li> </ul>	600
6	S 25° 27.506' E 152° 39.092'	Construct gravel trail 2.5 m wide compacted to 150mm thickness between WI 5 and	440,000



		Churchill Mine Rd Trailhead (5,500 m). Construction includes stripping of top soil, boxing out, filling, levelling, trimming, shaping and compacting gravel. Trail needs a 5m wide corridor.	
7		Allow moderate clearing between WI 5 and Churchill Mine Rd Trailhead (5,500 m).	38,500
8		Allowance for slashing of parallel bridle trail (5,500 m). (slashing may not be needed depending on clearing work but horse trail needs to be differentiated from pedestrian/cyclist trail).	27,500
9	S 25° 27.506' E 152° 39.092'	Erect post and wire fencing on southern side of new trail between WI 5 and Churchill Mine Rd Trailhead to differentiate from mining lease area (5,500 m).	82,500
10	S 25° 23.571' E 152° 41.210'	Install trail user chicane and management gate system and 5 m fencing either side of gating system. Set gating system in cement stabilised gravel "apron" for ease of maintenance.	3,540
11	S 25° 23.441' E 152° 41.567'	Churchill Mine Rd Trailhead (See Trailhead plan – Appendix 3). <ul style="list-style-type: none"> <li>• Install double-sided trailhead sign (\$1,600).</li> <li>• Install Trail Directional Marker (2) (\$1,200).</li> <li>• Grade and gravel 450m<sup>2</sup> parking area (\$36,000).</li> <li>• Install Trailhead map panel (\$5,500).</li> </ul>	44,300
		Allowance for additional landowner requests (e.g. fencing and vegetation screening).	0
		Allowance for installation of interpretive signage (at locations to be determined by trail manager and local historians) (3 signs).	9,000
		Allowance for new pre-fabricated bridge (1) and culverts (3) to deal with drainage	30,000

Allowance for making safe (e.g. fencing) of historic mines.	10,000
Allowance for Trail Directional Markers (incorporating emergency markers) to be placed along trail every 1 km.	4,200
Allowance for installation of trailside furniture (e.g. seats) at locations to be determined by trail manager (3 units).	6,000
Allowance for marking trees to be cleared, pruned or left untouched.	2,400
Allowance for marking centreline of trail with flagging tape prior to clearing and construction.	3,600
Allowance for purchase and installation of: <ul style="list-style-type: none"> <li>• Regulatory signage (Shared Path; “No Trail Bikes”; “Authorised Users Only”);</li> <li>• Road name signs;</li> <li>• Trail name signs;</li> <li>• “No Trespassing” signs;</li> <li>• Local attractions sign; and</li> <li>• Miscellaneous signs (Keep Out etc.).</li> </ul>	1,200
Allowance for traffic management (0 road crossings).	0
Allowance for cable locators at road crossings (0 road crossings).	0
<i>Sub-total</i>	<i>\$947,840</i>
Approvals, permits, applications, designs, specifications, assessments (2.5% of \$947,840)	23,700
Contingency amount (20% of \$947,840)	189,570
Project management (5% of \$947,840)	47,390
<b><i>TOTAL (NOT INCLUDING GST)</i></b>	<b><i>\$1,208,500</i></b>

**Table 5: Churchill Mine Road Trailhead to Walligan Trailhead (9.0km) (refer Plan 5 in Appendix 5)**

Works Item #	GPS Reference	Works Item	\$
		Churchill Mine Rd Trailhead (see Table 4).	0
1	S 25° 23.441' E 152° 41.567'	Construct new trail between Trailhead and road crossing (WI 2) (60 m). Cost includes clearing and trail construction.	4,980
2	S 25° 23.431' E 152° 41.608'	Road crossing – Churchill Mine Road. (See road crossing drawing - Appendix 1). <ul style="list-style-type: none"> <li>• Install “trail crossing” signs on both sides of trail (\$1,200).</li> <li>• Install “Give Way” signs on trail on both sides of road (\$400).</li> <li>• Install trail directional marker (1) (\$600).</li> </ul>	2,200
3		Construct new trail between road crossing (WI 2) and original railway formation (70 m). Construction includes clearing and trail construction.	5,810
4	S 25° 23.455' E 152° 41.655'	Install barrier on original rail formation to re-direct users. Install Trail Directional Marker (1). (GPS reference is the point where the original rail corridor crosses Churchill Mine Rd). Install Trail directional marker to send horse riders along management track south of proposed rail trail (\$600) – not shown on drawing.	2,200
5	S 25° 23.436' E 152° 41.665'	Construct trail between Churchill Mine Road and Walligan Trailhead (9,000 m). Construction includes stripping of top soil, boxing out, cleaning side drains, compacting subgrade (to 150mm), filling with road base, levelling, trimming, shaping and compacting.	540,000
6		Clearing between Churchill Mine Road and Walligan Trailhead.	46,300

		Allow heavy clearing along creek lines and other heavily overgrown areas (300 m). Allow moderate clearing (4,000 m). Allow minor clearing (4,700 m).	
		Allowance for slashing of parallel bridle trail – it is proposed that horses uses the vehicle track alongside the railway formation in this section until WI 32.	0
7	S 25° 23.418' E 152° 41.078'	Retain timber bridge (36.1 m). Install decking and handrails. 2010 Cardno report states that the bridge appears to be in generally good condition and would be suitable for re-purposing.  Bridge does have a go-round opportunity on adjoining management track and therefore does not need to carry vehicles.  <i>Cost based on 2017 re-use costs for timber bridge (5Kpa loading) on Piggford Lane-Walligan Trailhead section.</i>	149,130
8	S 25° 23.244' E 152° 41.951'	Install pre-fabricated bridge (12.1 m). Abutments remain. Significant amounts of standing water suggest bridge is the best option for crossing (rather than concrete floodway).  Bridge does have a go-round opportunity on adjoining management track and therefore does not need to carry vehicles.  <i>Cost based on 2010 Cardno report adjusted for inflation.</i>	46,500
9	S 25° 23.117' E 152° 42.142'	Install trail user chicane and management gate system and 5 m fencing either side of gating system (could extend to boundary fence where this is in place). Set gating system in cement stabilised gravel “apron” for ease of maintenance	3,540
10	S 25° 22.778' E 152° 42.774'	Install trail user chicane and management gate system and 5 m fencing either side of gating system (could extend to boundary fence where this is in place). Set gating system in cement stabilised gravel “apron” for ease of maintenance.	3,540

11	S 25° 22.721' E 152° 42.869'	Retain timber bridge (96.1 m). Install decking and handrails. 2010 Cardno report does not make definitive comment on state of bridge other than noting that timber girders appear to be in acceptable condition.  Bridge does have a go-round opportunity on adjoining management track and therefore does not need to carry vehicles.  <i>Cost based on 2017 re-use costs for timber bridge (5Kpa loading) on Piggford Lane-Walligan Trailhead section.</i>	396,990
12	S 25° 22.683' E 152° 42.949'	Install trail user chicane and management gate system and 5 m fencing either side of gating system (could extend to boundary fence where this is in place). Set gating system in cement stabilised gravel “apron” for ease of maintenance.	3,540
13	S 25° 22.653' E 152° 42.994'	Install management access gates in fencing parallel to trail on both sides. This appears to be a used crossing over point for vehicles. Ensure fence is in sufficient condition to support gates (some allowance for fence repair considered).	4,000
14	S 25° 22.536' E 152° 43.223'	Install trail user chicane and management gate system and 5 m fencing either side of gating system (could extend to boundary fence where this is in place). Set gating system in cement stabilised gravel “apron” for ease of maintenance.	3,540
15	S 25° 22.498' E 152° 43.278'	Retain timber bridge (24.4 m). Install decking and handrails. 2010 Cardno report does not make definitive comment on state of bridge other than noting that timber girders appear to be in acceptable condition.  Bridge does have a go-round opportunity on adjoining management track and therefore does not need to carry vehicles.  <i>Cost based on 2017 re-use costs for timber bridge (5Kpa loading) on Piggford Lane-Walligan Trailhead section.</i>	99,560



16	S 25° 22.464' E 152° 43.362'	Install trail user chicane and management gate system and 5 m fencing either side of gating system (could extend to boundary fence where this is in place). Set gating system in cement stabilised gravel “apron” for ease of maintenance.	3,540
17	S 25° 22.372' E 152° 42.519'	Install management access gates in fencing parallel to trail on both sides. This appears to be a used crossing over point for vehicles. Ensure fence is in sufficient condition to support gates (some allowance for fence repair considered).	4,000
18	S 25° 22.191' E 152° 43.844'	Install pre-fabricated bridge (42.7 m). Abutments remain. 2010 Cardno report recommends that bridge be replaced due to fire damage and timber removed from what is left could be used on other bridges.  Bridge does have a go-round opportunity on adjoining management track and therefore does not need to carry vehicles.  <i>Cost based on 2010 Cardno report adjusted for inflation.</i>	139,165
19	S 25° 22.166' E 152° 43.903'	Install trail user chicane and management gate system and 5 m fencing either side of gating system (could extend to boundary fence where this is in place). Set gating system in cement stabilised gravel “apron” for ease of maintenance.	3,540
20	S 25° 22.144' E 152° 43.933'	Install management access gates in fencing parallel to trail on both sides. This appears to be a used crossing over point for vehicles. Ensure fence is in sufficient condition to support gates (some allowance for fence repair considered).	4,000
21	S 25° 22.003' E 152° 44.223'	Install management access gates in fencing parallel to trail on both sides. This appears to be a used crossing over point for vehicles. Ensure fence is in sufficient condition to support gates (some allowance for fence repair considered).	5,000

22	S 25° 21.972' E 152° 44.314'	Install management access gates in fencing parallel to trail on both sides. This appears to be a used crossing over point for vehicles. Ensure fence is in sufficient condition to support gates (some allowance for fence repair considered).	5,000
23	S 25° 21.570' E 152° 44.720'	Install trail user chicane and management gate system and 5 m fencing either side of gating system (could extend to boundary fence where this is in place). Set gating system in cement stabilised gravel “apron” for ease of maintenance.	3,540
24	S 25° 21.529' E 152° 44.755'	Install management access gates in fencing parallel to trail on both sides. This appears to be a used crossing over point for vehicles. Ensure fence is in sufficient condition to support gates (some allowance for fence repair considered).	5,000
25	S 25° 21.533' E 152° 44.749'	Formation is indistinguishable from road in both directions. Formation and road have been built in same place (road built over formation previously to access yards and houses on both sides). Use constructed road as a shared facility (grade and gravel work to be done – 400 metres long). Trail to share access road (low vehicle/low speed envisaged). Install shared zone signage.	400 (Grading and gravelling covered in WI 5)
26	S 25° 21.422' E 152° 44.906'	6 box culvert (under road that has been built on formation). Clean out and maintain.	600
27	S 25° 21.402' E 152° 44.945'	Install trail user chicane and management gate system and 5 m fencing either side of gating system (could extend to boundary fence where this is in place). Set gating system in cement stabilised gravel “apron” for ease of maintenance. Provide landowners on either side of corridor with access. Use constructed road to bring trail users to Takura trailhead.	

28	S 25° 21.303' E 152° 45.096'	Takura Trailhead (See Trailhead plan – Appendix 3). <ul style="list-style-type: none"> <li>• Install Trailhead map panel in gravel semi-circle (\$6,000).</li> <li>• Reinstate siding nameboard (\$2,000).</li> <li>• Install Trail Directional Marker (1) (\$600).</li> <li>• Install single-sided chevron trailhead sign (\$1,000).</li> <li>• Install double-sided chevron trailhead sign (\$1,600).</li> <li>• Slash growth to connect trailhead with trail and construct 10 m trail (\$1,000).</li> <li>• Install hitching rails (\$1,200).</li> </ul>	13,400
29	S 25° 21.276' E 152° 45.128'	Road crossing – Torbanlea Pialba Road. (See road crossing drawing - Appendix 1). <ul style="list-style-type: none"> <li>• Install “trail crossing” signs on both sides of trail (\$1,200).</li> <li>• Install “Road ahead” signs on trail on both sides of road (\$400).</li> <li>• Install “Stop” signs on trail on both sides of road (\$400).</li> <li>• Install trail user chicane and management gate system and 5 m fencing either side of gating system (north side of road only). Set gating system in cement stabilised gravel “apron” for ease of maintenance. (Install beyond WI 30 – not shown as such on drawing) (\$3,540).</li> <li>• Remove cross fence (\$200)</li> <li>• Install Trail directional marker to send horse riders along management track north of proposed rail trail (\$600) – not shown on drawing.</li> </ul>	5,740
30	S 25° 21.189' E 152° 45.266'	Install bridge (61 m). Abutments remain. 2010 Cardno report suggests these can be reused. Bridge does have a go-round opportunity on adjoining management track and therefore does not need to carry vehicles.	270,800

<i>Cost based on 2010 Cardno report adjusted for inflation.</i>			
31	S 25° 20.813' E 152° 45.839'	Install trail user chicane and management gate system and 5 m fencing either side of gating system (could extend to boundary fence where this is in place). Set gating system in cement stabilised gravel “apron” for ease of maintenance.	3,540
32	S 25° 20.734' E 152° 45.904'	Horse riders come onto rail trail. Slash parallel bridle trail to Walligan Trailhead (490m).	2,450
33	S 25° 20.704' E 152° 46.001'	Install bridge (61 m). Abutments remain. 2010 Cardno report suggests an option for reusing existing concrete plinths.  Bridge does have a go-round opportunity on adjoining management track and therefore does not need to carry vehicles.  <i>Cost based on 2010 Cardno report adjusted for inflation.</i>	344,630
34	S 25° 20.539' E 152° 46.248'	Walligan Trailhead (See Trailhead plan – Appendix 3).  Improve existing trailhead <ul style="list-style-type: none"> <li>• Install Trail Directional Marker (1) (\$600).</li> <li>• Grade and gravel 400m<sup>2</sup> parking area (\$32,000).</li> <li>• Install Trailhead map panel in a semi-circular gravelled area (12m<sup>2</sup>) (\$5,500).</li> <li>• Reinstate siding nameboard (\$2,000).</li> <li>• Replace existing exclusion post with chicane gating system (\$3,540).</li> </ul>	43,640
35	S 25° 20.499' E 152° 46.333'	Dundowran Rd crossing. Install double-sided trailhead sign (brown chevron).	1,600
		Allowance for additional landowner requests (e.g. fencing and vegetation screening).	10,000
		Allowance for installation of additional interpretive signage (at locations to be	6,000

determined by trail manager and local historians) (2 signs).	
Allowance for Trail Directional Markers (incorporating emergency markers) to be placed along trail every 1 km.	5,400
Allowance for installation of trailside furniture (e.g. seats) at locations to be determined by trail manager (3 units).	6,000
Allowance for clearing of existing culverts (10).	4,000
Allowance for marking trees to be cleared, pruned or left untouched.	2,400
Allowance for marking centreline of trail with flagging tape prior to clearing and construction.	3,600
Allowance for purchase and installation of: <ul style="list-style-type: none"> <li>• Regulatory signage (Shared Path; “No Trail Bikes”; “Authorised Users Only”);</li> <li>• Road name signs;</li> <li>• Trail name signs;</li> <li>• “No Trespassing” signs;</li> <li>• Local attractions sign; and</li> <li>• Miscellaneous signs (Keep Out etc.).</li> </ul>	1,200
Allowance for traffic management (3 road crossings).	6,000
Allowance for cable locators at road crossings (3 road crossings).	3,000
<i>Sub-total</i>	<i>\$2,219,015</i>
Approvals, permits, applications, designs, specifications, assessments (2.5% of \$2,219,015).	55,475
Contingency amount (20% of \$2,219,015).	443,805
Project management (5% of \$2,219,015).	110,950
<b><i>TOTAL (NOT INCLUDING GST)</i></b>	<b><i>\$2,829,245</i></b>





Table 6: Piggford Lane to Nikenbah (1.0km) (refer Plan 6 in Appendix 5)



Works Item #	GPS Reference	Works Item	\$
1	S 25° 19.629' E 152° 47.682'	Piggford Lane Road crossing. (See road crossing drawing - Appendix 1). <ul style="list-style-type: none"> <li>• Install “Give Way” sign on northern side of road (\$400).</li> <li>• Install “trail crossing” signs on road on both sides of trail (\$1,200).</li> <li>• Install trail user chicane and management gate system and 5 m of fencing on either side perpendicular to direction of travel (north side of road). Set gating system in cement stabilised gravel “apron” for ease of maintenance. (\$3,540).</li> <li>• Create a 5 m (l) x 2.5m (w) asphalt “apron” connecting road shoulder with trail on west side of road (note: apron not shown on drawing) (\$1,200).</li> </ul>	6,340
2	S 25° 19.629' E 152° 47.682'	Construct trail between Piggford Lane and Maryborough Hervey Bay Rd underpass (950 m). Construction includes stripping of top soil, boxing out, cleaning side drains, compacting subgrade (to 150mm), filling with road base, levelling, trimming, shaping and compacting.	57,000
3	S 25° 19.629' E 152° 47.682'	Clearing between Piggford Lane and Maryborough Hervey Bay Rd underpass Allow heavy clearing (475m). Allow moderate clearing along remainder (475 m).	9,975
4	S 25° 19.555' E 152° 47.712'	Midpoint of small cutting. Attend to side drainage in cutting: Construct trail to a depth of 300mm (rather than a standard 150mm) (80m).	1,600
5	S 25° 19.346' E 152° 47.889'	Small box drain. Clean out and maintain. (no other drains in this section).	400

6	S 25° 19.302' E 152° 47.944'	<p>Install pre-fabricated bridge (9.2 m). Abutments remain – the 2010 Cardno report identified that these could be re-used.</p> <p>Significant amounts of standing water suggest bridge is the best option for crossing (rather than concrete floodway).</p> <p>Bridge does not have a go-round opportunity but given distances between road crossings this is not an issue and bridge does not need to carry vehicles.</p> <p><i>Cost based on 2010 Cardno report adjusted for inflation.</i></p>	38,600
7	S 25° 19.236' E 152° 48.019'	Nominal landing point for underpass on south western side of Maryborough Hervey Bay Road.	0
8	S 25° 19.225' E 152° 48.048'	Nominal centre point of underpass (under Maryborough Hervey Bay Rd).	3,000,000 (cost requested by FCRC)
9	S 25° 19.190' E 152° 48.087'	<p>Adjoining landholder moves machinery across the corridor at this location and would like to maintain option to do so.</p> <p>Install 10 m post and wire fence on either side of trail (north and south) and management access gate in fence (both sides) which landholder has the key for.</p>	1,150
		Allowance for additional landowner requests (e.g. fencing and vegetation screening).	2,000
		Allowance for installation of additional interpretive signage (at locations to be determined by trail manager and local historians) (0 signs).	0
		Allowance for Trail Directional Markers (incorporating emergency markers) to be placed along trail every 1 km.	1,200
		Allowance for installation of trailside furniture (e.g. seats) at locations to be determined by trail manager (0 units).	0

Allowance for marking trees to be cleared, pruned or left untouched.	1,200
Allowance for marking centreline of trail with flagging tape prior to clearing and construction.	1,200
Allowance for purchase and installation of: <ul style="list-style-type: none"> <li>• Regulatory signage (Shared Path; “No Trail Bikes”; “Authorised Users Only”);</li> <li>• Road name signs;</li> <li>• Trail name signs;</li> <li>• “No Trespassing” signs;</li> <li>• Local attractions sign; and</li> <li>• Miscellaneous signs (Keep Out etc.).</li> </ul>	600
Allowance for traffic management (1 road crossing – underpass construction includes all road crossing management).	2,000
Allowance for cable locators at road crossings (1 road crossing – underpass construction includes all road crossing management).	1,000
<i>Sub-total</i>	<i>\$3,124,265</i>
Approvals, permits, applications, designs, specifications, assessments (2.5% of \$3,124,265).	78,105
Contingency amount (20% of \$3,124,265).	624,855
Project management (5% of \$3,124,265).	156,215
<b><i>TOTAL (NOT INCLUDING GST)</i></b>	<b><i>\$3,983,440</i></b>

Additional works item for this section could be required if a proposal to create a railway museum at the old Nikenbah School site on Aarlborg Rd proceeds. This would make a logical diversion for trail users and could provide an additional trailhead in this vicinity. No costs have been included but likely works items would include:

-  A spring-loaded user gate system co-located with WI 9 (above) to allow users off the rail trail to head towards the school house.
-  Trail Directional markers at road/trail junctions.

-  Appropriate signage to allow shared use of Aarlborg Rd South and to direct users safely across Chapel Rd.
-  Trailhead facilities either within the school grounds or in the large open space on the south-eastern side of Aarlborg Rd North. The trailhead would be developed as a minor trailhead with only a map panel and directional signage and some gravelled parking.

**Table 7: Total Costs: Mary to Bay Rail Trail**

Section	Cost
Section 1: Maryborough Trailhead to Maryborough West Trailhead	\$2,392,475
Section 2: Maryborough West Trailhead to Quarry Rd	\$316,595
Section 3: Quarry Rd to Colton siding	\$2,729,855
Section 4: Colton siding to Churchill Mine Rd Trailhead	\$1,208,500
Section 5: Churchill Mine Rd Trailhead to Walligan Trailhead (existing trailhead)	\$2,829,245
Section 6: Piggford Lane to Nikenbah	\$3,983,440
<b>Total (excluding GST)</b>	<b>\$13,460,110</b>







## SECTION 5 - CONSTRUCTION MANAGEMENT

Should the trail proceed, prior to the construction of the rail trail between Maryborough and Walligan Trailhead (and between Piggford Lane and Nikenbah) the project manager should prepare a Construction Management Plan (CMP).

The purpose of a Construction Management Plan is to provide a framework reference document detailing how the Council and any contractors will manage and control aspects of the trail construction. The CMP will be used as a working document to ensure that obligations and commitments provided in the relevant licences, permits and approvals are made known to all site personnel and implemented effectively as an integral part of trail construction.

















It also aims to detail processes to minimise impacts associated with the construction of the rail trail on adjacent areas. Given sufficient thought and consideration prior to construction, risks can be mitigated and impacts can be minimised. While there are a minimum number of adjoining landholders, it is still relevant to consider all the issues that may arise with them during construction.

Concerns of adjoining landholders during construction often include:

-  Adjoining landowners are to be advised well in advance of construction activity taking place.
-  Construction machinery and contractors' vehicles are not to use private property or private roads to access the former railway corridor (except where permission has been granted). Access should either be along the corridor or adjacent gazetted roads.
-  Fencing needs to be maintained at all times during construction.
-  Contractors and Council employees are not to trespass on private property during construction (unless prior written agreement is obtained from the landowner).
-  Spread of weeds along the corridor by construction machinery is to be controlled and minimised. Vehicle and machinery wash down facilities are needed.
-  Leaving of rubbish within the corridor during/after construction of the trail should not occur.
-  Construction crews should work closely with adjoining landowners over various issues, such as water pipes that cross the corridor, location of machinery and stock crossings, new fencing etc.

The general process for the development of the Mary to Bay Rail Trail will involve a number of tasks. Tasks to be undertaken include:



-  Notification of adjoining landowners well in advance of construction commencing.
-  Ongoing consultation with adjoining landowners to clarify/confirm need for, and precise location of, requested items. The works tables include very few items requested by adjoining landholders – this may change as the project builds momentum. In addition, the landholders who have yet to be fully engaged – notably the landholder who owns land between Bronze Street and Saltwater Creek (where acquisition is proposed) and the landholder who farms the parcel of land owned by Fraser Coast Regional Council south of Saltwater Creek have not been formally approached and may require or request additional works items. Works items to be provided and their precise location will need to be negotiated as it will depend on landholder requirements at the time of construction.
-  Negotiation on access to sites.
-  Removal of cross fences where they still exist (though there are very few cross fences).
-  Installation of new side fencing and gates (where required) and/or relocation of existing fencing.
-  Clearing of regrowth vegetation, and removal of weeds.
-  Identification and establishment of stockpile locations and machinery wash down facilities.
-  Utility identification/relocation (if required). This will be a critical issue within Maryborough (out to Maryborough West trailhead).
-  Environmental and other surveys (e.g. flora if required, site pegging and on ground delineation).
-  Replacement/reinstatement of culverts and bridges.
-  Installation of erosion and sediment controls such as silt fences.
-  Haulage and stockpiling of material.
-  Trail base layers and surfacing.
-  Installation of signage (including warning, advisory, trailhead, distance / directional, emergency and interpretive signage).
-  Installation of management access gates, and chicanes and associated fencing.
-  Landscaping and revegetation.
-  Site clean-up.

Negotiations over the use of parcels of land and shared corridors is not included in this list but is discussed in Section 6.

Consideration will need to be given to the following matters in the preparation of the CMP:

#### LANDHOLDER COMMUNICATION PLAN

---

The Council should prepare a Landholder Communication Plan before work commences to ensure that all adjacent landowners are aware of the construction program well in advance and are individually consulted regarding exact placement of recommended works items.

#### SAFE WORK METHOD STATEMENT (SWMS)

---

A Safe Work Method Statement (SWMS) documents a process for identifying and controlling health and safety hazards and risks. Under Occupational Health and Safety Regulations, a SWMS must be prepared before high risk construction work begins, if anyone's health and safety is at risk because of the work, but SWMS can be used for any other work activities. A SWMS is designed to help contractors and their employees think through the hazards and risks involved in the work, and to choose effective control measures. As a matter of course, a SWMS will be required, and the CMP must address all risks and address how they will be controlled. Matters to be addressed include construction activity at road crossings.

#### PREPARATION OF OTHER WORKS METHOD STATEMENTS

---

The appropriate environmental authorities (prior to work commencing) may require several other 'Works Method Statements' such as Clearing Work Method Statement, Minor Earth Works Method Statement and Drainage Works Method Statement. These statements will address a range of potential concerns such as the spread of weeds during vegetation clearing (on and offsite), water pollution or sedimentation due to working near to watercourses, and the discovery or impact to any new sites of Aboriginal or non-Aboriginal heritage or archaeological sites.

#### ENVIRONMENTAL AND OTHER SURVEYS (E.G. FLORA IF REQUIRED, SITE PEGGING AND ON GROUND DELINEATION)

---

Prior to selection of stockpile sites and construction activity, it may be necessary to carry out a variety of environmental and other surveys. The CMP will need to schedule the activity to occur at appropriate times of the year, and prior to construction.

#### GEOTECHNICAL/ENGINEERING INVESTIGATIONS FOR DRAINAGE CROSSINGS

---

Various investigations may be required at and around watercourses prior to reinstatement of the bridges and culverts. The CMP will need to schedule in this activity prior to construction occurring at these sensitive locations.

#### UTILITY IDENTIFICATION/RELOCATION

---

Fieldwork revealed the existence of utilities (telecom cabling etc) within the corridor. The CMP should allow for a cable locator to establish the precise locations of utilities and services prior to construction activity occurring. This will be a major issue in Maryborough and will also need critical analysis during planning of the underpass of Maryborough Hervey Bay Road.

#### INSTALLATION OF NEW GATES AND FENCES AND STOCK CROSSINGS

---

It may be necessary, in order to ensure stock are kept out of the rail trail corridor, to repair or relocated or erect new fencing erected along parts of the corridor. This was not obvious during fieldwork – the more critical issue with fencing is around preventing unauthorised vehicle access to the corridor during construction. This activity should be undertaken early in the construction process. Cooperation and consultation with adjoining landowners will be required to ensure any new fencing is installed in the appropriate location and that stock crossings (if any) are located in the optimum locations. One obvious location where new fencing will be required to manage stock is on the proposed trail route on Road 21 – the adjoining landholder currently grazes up to the active railway line and would like to maintain grazing “rights”. If a trail is constructed on the road reserve, it would be on the edge of the active railway corridor boundary and would only require a 5 metre width. The landholder can continue to graze the “left-over” road reserve but fencing would be needed to be erected early in the construction process.

#### FENCING AND STOCK CONTROL DURING CONSTRUCTION

---

Construction of the rail trail will mean numerous (existing) fences erected across the corridor (particularly at property boundaries and road crossings) will need to be removed. One of the first steps in construction will be to erect new fences and gates (where appropriate) to ensure stock are contained to their paddocks and to ensure construction machinery have unlimited access along the corridor. The CMP will need to program this activity, including the necessary consultation with adjoining landowners and contractors. Again, this is not envisaged to be a major task given the limited use of the corridor for grazing.

#### SELECTION OF MATERIAL STOCKPILE SITES

---

Construction of the rail trail will involve the removal of material from the corridor (old fencing material, miscellaneous waste/rubbish material) and the delivery of materials to be used in the construction of the trail (gravel, fencing materials, bridge components, etc). Numerous stockpile sites will be required along the alignment to enable the management of surfacing material, culvert materials, fill and potentially topsoil and vegetation. Care will need to be taken to ensure the selected sites are safely located, secure, and minimise the invasion of the privacy of neighbours of the proposed rail trail. The stockpile sites should also be located on already cleared sites (minimising the vegetation clearing requirements) and with little or no impact on

watercourses or other environmentally sensitive sites. It is imperative that access to the corridor be via public land, unless agreement has been obtained from neighbouring landowners. Preparation of the CMP should address these issues.

#### REMEDIATION OF CONTAMINANTS ALONG FORMATION

---

Although no contamination investigations are known to have been undertaken, it is possible that there are contaminants in the soil from years of maintenance of the railway track, railway corridor and associated infrastructure. The CMP should specify how potential contamination is to be dealt with.

#### DE-CONTAMINATION OF CONSTRUCTION EQUIPMENT

---

As good practice, it is imperative that any construction equipment be kept clean. The CMP should specify the process by which construction equipment will be kept clean of potential diseases, weeds and contaminants.

#### MANAGEMENT OF FIRE RISK (INCL. SPARK CONTROL)

---

There is a risk of accidental fires being caused by sparks from machinery. The CMP will need to address ways of ensuring fires are not inadvertently caused by the construction activity, and consideration given to the time of the year that different construction activities are undertaken. The CMP will identify the general requirements regarding fire prevention and management during construction, especially at times of total fire ban.

#### WEED MANAGEMENT – CONTROL AND ERADICATION

---

There is a legal obligation to control noxious weeds. The control/eradication of weeds within the former railway corridor is of particular importance and the CMP will need to ensure that construction of the rail trail does not cause weeds to spread.

#### MARKING TREES FOR RETENTION OR REMOVAL

---

In many areas vegetation has re-grown within the former railway corridor. In places (particularly along creek and drain lines), this regrowth is quite thick. Clearing of (some of) the regrowth vegetation will be required. However, some of the regrowth should be retained to provide shade for trail users, as it is sufficiently clear of the proposed trail corridor so as to not be of concern. In some cases, it also forms a natural barrier between the corridor and adjoining landholders providing visual barriers. Prior to construction commencing trees that are to be retained (for their shade and aesthetic values) should be marked with flagging tape. The CMP should specify the process for marking trees for retention.

## CLEARING, MULCHING AND DISPOSAL OF WASTE VEGETATIVE MATERIAL

---

Some regrowth vegetation will need to be removed from the rail trail corridor. The CMP will address the process for clearing, and the manner in which vegetative material will be removed from the corridor (such as by mulching and spreading in the immediate area or by other methods).

## EROSION CONTROL AND DRAINAGE ALONG CORRIDOR

---

The railway (when operating) had functional erosion control techniques in place. The construction of the rail trail must ensure that no damage is done to existing drainage channels and erosion control devices and that erosion is mitigated rather than exacerbated. This is particularly important when working in and around the numerous watercourses, along embankments and through cuttings. The CMP will need to address how erosion will be controlled, both during the construction of the rail trail and afterwards.

## POLLUTION CONTROL AT WATERCOURSES/BRIDGES

---

There will be considerable construction activity in the vicinity of watercourses at the time when bridges and culverts are being replaced and/or refurbished. The CMP will need to specify the installation of erosion and sediment controls, such as silt fences, to be deployed at sensitive locations such as bridges and other watercourses. Utmost care needs to be taken to avoid damage to banks of creeks.

## ACCESS CONSIDERATIONS

---

The CMP will need to determine the most efficient means of access to all parts of the corridor (and to stockpile sites), with minimal noise, dust and inconvenience to nearby residents. Given the large number of road crossings, access should not be an issue but disturbance to nearby residents during construction may be an issue.

## TRAFFIC CONTROL

---

There are 5 road crossings along the proposed rail trail and other locations (particularly in Maryborough and at the Maryborough Hervey Bay Road underpass) where construction activity will occur around road crossings. Each road crossing will require various improvements, such as the construction of the trail, the installation of gates and fencing, and the installation of signage. The CMP will need to address the issue of traffic management and control to ensure the safety of contractors involved in construction activity in the vicinity of each road crossing.

## SECTION 6 – AN IMPLEMENTATION PROGRAM

### 6.1 TRAIL CONSTRUCTION STAGES

Development of trails can often be staged so that parts of trails are developed in line with available funding sources. It is often not possible to open the full length of a trail simultaneously as significant physical, financial, community and institutional work needs to be undertaken. This is the case in many rail trails (and indeed many recreational trails) around Australia. Opening a new trail in stages also allows those who are opposed or undecided about a project to see a clear demonstration of its use and lack of issues (almost inevitably, problems identified by concerned people do not arise).

A staged approach to planning and development is often the best approach as it better suits the capacity of the entity charged with delivering the project.

The Feasibility Study suggested an order of construction based on a number of factors. It is reproduced below with updated costs (Table 8). However, construction stages can change and Council will need to take into account a number of factors. This may include adjoining landholder concerns and opposition, and stage costs and approval processes. Fraser Coast Regional Council can determine which stages should be constructed in what order to suit its circumstances at the time the trail proceeds.

**Table 8: Construction Stages**

Construction	Stage	Length	Cost
1	Piggford Lane to Nikenbah	1 km	\$3,983,440
2	Maryborough Trailhead to Maryborough West Trailhead	4.3 km	\$2,392,475
3	Churchill Mine Rd Trailhead to Walligan Trailhead	9.0 km	\$2,829,245
4	Maryborough West Trailhead to Quarry Rd	2.9 km	\$316,595
5	Quarry Rd to Colton siding	7.7 km	\$2,729,855
6	Colton siding to Churchill Mine Rd Trailhead	7.0 km	\$1,208,500



## 6.2 USE OF THE EXISTING ACTIVE RAIL CORRIDOR IN MARYBOROUGH

The Feasibility Study included detailed discussions of the rail route from Maryborough Trailhead to Maryborough West Trailhead. Section 3 also provides a summary of design issues around trail alignment. In terms of trail implementation, it is in the interests of Fraser Coast Regional Council as the trail proponent to initiate discussions with Queensland Rail and the Downer Group to determine a way forward. There would also be a role for the Department of Transport and Main Roads given its interest in developing rail trails across Queensland. The trail development planning process has proceeded by assuming that the existing corridor will be used and has provided more parameters for this discussion, including design recommendations. Discussions and negotiations now need to be initiated by FCRC.

## 6.3 LAND ACQUISITIONS/EASEMENTS

As discussed in Section 3, some of the land north of Saltwater Creek where the trail should be developed is owned by the State Government and some owned by a private individual. The ownership data means that a strip of approximately 130 metres (x 5 m wide) of privately owned land would be required for the trail (on the basis that the State Government provides access to the parcel it owns). In addition, discussions with the landholder may need to include an easement or purchase to ensure that a bridge can be landed on the northern side of the creek (this bridge would be some 50 metres downstream of the active line railway bridge). It is in the interests of Fraser Coast Regional Council as the trail proponent to initiate necessary discussions with both Queensland Rail and the landholder. The trail development plan has provided more parameters for this discussion.

## 6.4 A TRAIL ALONGSIDE AN ACTIVE RAIL LINE NORTH OF ALDERSHOT

The use of Road 21 and the fencing recommended in Section 4 should mean that developing the trail alongside the active railway line from Aldershot to Colton will not be a major issue for the rail operator. However, it is in the interests of Fraser Coast Regional Council as the trail proponent to initiate necessary discussions with the rail operator.

## 6.5 USE OF FCRC LAND SOUTH OF SALTWATER CREEK

Examination of Council's property database indicated that Fraser Coast Regional Council owns a large property which runs immediately east of the original railway corridor south of Saltwater Creek (it appears to be used for farming purposes). As recommended in the Feasibility Study, the best solution is for Council to provide a trail along the western boundary of its property. Council (both the unit responsible for the trail development and Wide Bay Water) should initiate discussions with the lessee of the land to facilitate the trail's development.

## 6.6 MINING LEASE





The presence of a mining lease over part of the former railway corridor at Colton has been a significant issue since the original proposal for a rail trail. The trail development planning process has assumed that the suggested alternative route north of the mining lease will be used. Negotiations with the mining lease holder cannot be undertaken at this stage. It is not clear as to how this matter will proceed. What is of particular importance is that the condition of the mining lease is that the mining company has a responsibility for acquiring land for an alternative trail corridor and must contribute to its construction. The lease condition also requires the company to identify an alternative corridor from Churchill Mine Rd to Saltwater Creek Road. This option was explored in the Feasibility Study and a route in this general area i.e. east of the mining lease was deemed not to be a feasible option due to the length of diversion necessary. This Trail Development Plan recommends developing the trail on unallocated State land north of the mining lease and on the road reserve known as Road 21, which may be in the mining lease area but is along one edge which will limit its interaction with actual mining. The deviation around the mining lease should be limited and the recommended route delivers on that outcome.

The mining lease applications submitted by the New Hope Group in 2010 identified that the land within the Mining Lease Area is Unallocated State Land, except for the (presently unused) rail land and the road. The land is owned by the State Government and administered by the Department of Environment and Resource Management. Unallocated State Land will not extinguish native title. Similar rules would apply to the Unallocated State Land north of the mining lease proposed to be used. A native title claim over a much larger area including the proposed location of the rail trail was lodged in 2009 (Butchulla Land and Sea Claim #2). Parts of the claim have been subject to determinations but not the section covering the area in question. If the rail trail proceeds on the Unallocated State Land, it is unclear of the impact of the native title claim nor is it clear what the timeframe for determination is. Cultural heritage surveys may be required prior to any construction activity. Colton Coal carried out such surveys for the mining lease areas (which abut the proposed trail route). No sites or items of cultural significance were identified. Earlier mining activity in the late 1800s and early 1900s may have removed or destroyed cultural heritage items.

Should the existing mining lease be revoked or extinguished, Fraser Coast Regional Council and the Department of Transport and Main Roads should lobby the appropriate authority in an effort to ensure any new lease does not sterilise the existing railway corridor but rather allows it to be used for the rail trail. Under such circumstances, the Road 21 road reserve would still be used to connect Colton siding to Aldershot (the road reserve should also be excluded from any new mining lease).

## 6.7 ENVIRONMENTAL ISSUES

A number of key environmental issues have been identified. These include:

-  Clearing of regrowth vegetation along the corridor, and the need for clearing permits and the possible future need for offset re-vegetation.
-  The potential for the spread of weeds (and pathogens) during the construction phase and, potentially, through usage of the trail.
-  Contamination of soils as a result of the operations of the railway and the manner in which former bridges were constructed and maintained.
-  The potential for sedimentation of watercourses as a result of trail construction and bridge works.

In addition, care will need to be taken in the ongoing maintenance of the proposed rail trail to ensure weeds and pathogens are not unwittingly spread by maintenance machinery. Ongoing clearing at the sides of the rail trail will be required to keep the trail corridor at acceptable widths.

## 6.8 MANAGEMENT STRUCTURE

Once a decision is taken to proceed with the development of the proposed rail trail between Maryborough and Walligan trailhead, decisions will need to be made about the management regime that will be put in place to manage and maintain the trail. A serious commitment to long term management by the trail's proponents will be required, particularly as there is likely to be a significant investment of Government funds.

Management structures and roles were discussed extensively in the Feasibility Report. As noted in the Feasibility Report, the Queensland Government has not given any indication as to how any new rail trails will be managed. What exists on rail trails presently is a combination of State and Local Government and community groups.

If the trail proceeds, Fraser Coast Regional Council in cooperation with the State Government will need to determine the best management structure. It would be the best outcome if the structure can be determined and put in place at an early stage of the project. It should be put in place before construction begins. Whatever structure is put in place, it should be responsible for managing the entire Mary to Bay Rail Trail (i.e. from Maryborough to Urangan).

## SECTION 7 – CORRIDOR MANAGEMENT AND OPERATIONS PLAN

### 7.1 A CORRIDOR MANAGEMENT PLAN





As the trail development planning moves towards completion and the various landowner and development issues are resolved, a number of decisions need to be made about the ongoing management, operation and maintenance of the rail trail.

The best approach to deal with these issues is through a Corridor Management Plan, which forms the basis for ongoing trail management, operation and maintenance. A well-prepared and comprehensive corridor management plan (undertaken in close consultation with the community and neighbouring landowners) serves to ensure the rail trail functions and operates as a high-quality experience.

The following information is provided for information so that Fraser Coast Regional Council (and any Committee of Management set up to progress the project) can consider a range of factors in managing the trail.

#### 7.1.1 WHAT IS IN A CORRIDOR MANAGEMENT PLAN?











There are four major components to a Corridor Management Plan:





-  A 'Trail Policy' or a set of Guiding Principles which incorporates a set of decisions made about how the rail trail will operate;
-  A Trail Management Plan;
-  An Emergency Response Plan (incorporating a Fire Management Plan); and
-  A Trail Maintenance Plan.

Bringing all four elements together in one framework (a Corridor Management Plan) makes ongoing trail development and management an efficient process and ensures ongoing seamless transitions as personnel involved with the trail change over time.

#### 7.1.2 GUIDING PRINCIPLES





The preparation of a set of overarching principles is a useful exercise. Adherence to these principles will serve as a guide to the use, upgrading, maintenance, promotion and management of the Mary to Bay Rail Trail. The following principles provide guidance for the Council (and have been adopted from several other rail trail projects). The scope of principles indicates the scope of issues considered in the development of the Rail Trail. It should be noted that these may conflict or add to any existing principles Fraser Coast Regional Council has for managing the Links Mobility Corridor. The entire Mary to Bay Trail needs to be managed as one entity – the principles and decisions need to apply along the entire trail.

-  **Access for all** - where practical and appropriate, the Mary to Bay Rail Trail will be developed/upgraded to enable access by as wide a range of potential users as possible including people in wheelchairs, people with disabilities, family groups and the elderly. *Fraser Coast Regional Council will need to determine surfacing requirements and the promotion of the trail as access for all abilities if one or two sections are sealed (the existing Links Mobility Corridor and the proposed Maryborough Trailhead to Maryborough West trailhead) and the remainder is unsealed.*
-  **Providing enhanced outdoor recreational opportunities** - the Mary to Bay Rail Trail will be promoted as an additional component to the range of low cost outdoor recreational opportunities within the Fraser Coast region.
-  **Minimal conflict between trail users** – the Mary to Bay Rail Trail will cater for walkers and cyclists with minimal conflict.
-  **Providing access to, and an enhanced understanding of, the natural attributes of the Fraser Coast region** - the Fraser Coast region has a diverse and outstanding range of physical attributes, and the Mary to Bay Rail Trail will contribute to the provision of greater opportunities to access these natural features.
-  **Providing access to and an enhanced understanding of the history of the Fraser Coast region** - the many physical reminders of past land uses and activities can be a major component of interpretive information available on the Mary to Bay Rail Trail, and a greater inducement for visitors to use the trail.
-  **Quality promotion** - the trail manager will give significant emphasis to promoting the Mary to Bay Rail Trail as part of a broader visitor experience of the region.
-  **Effective and ongoing maintenance** - the Mary to Bay Rail Trail will be the subject of a regular maintenance regime, and a detailed audit every 2–3 years, ensuring that all defects along the trail receive quick attention, thereby keeping the trail up to the requisite standard and quality.
-  **Quality construction** – the Mary to Bay Rail Trail will be built to appropriate standards, and to a high quality, thereby minimising the need for maintenance, and giving users a quality experience.
-  **Quality information**, including brochures and mapping - the Mary to Bay Rail Trail will have quality on-trail information, as well as a professionally produced and widely available trail brochure and map. All means of distribution of trail information need to be utilised, including a web site and social media.
-  **Outstanding interpretive material** - the Mary to Bay Rail Trail will have on-trail interpretive material and will be included within other trail and publicity brochures, providing trail users with a greater appreciation of the more interesting features to be found along the trail.





-  **Consistency and uniformity of signage** - signage is recognised as an essential element of a quality trail, and all signage erected at trailheads, along nearby and adjoining roads and along the Mary to Bay Rail Trail will conform to accepted standards and will maintain a consistent theme along the entire trail. There is a need for signage to be consistent with existing signage on the Links Mobility Corridor – where this signage is appropriate.
-  **Adherence to recognised standards** - trail construction, signage and trail markers, and trail classification will comply with recognised Australian Standards, thereby ensuring a high quality and safe experience for all trail users.
-  **Community involvement** – the management and maintenance of Mary to Bay Rail Trail will consistently seek to involve adjoining landowners and the local communities along the corridor on an on-going basis and in the formulation of critical decisions. This on-going involvement with adjoining landowners and the community will ensure that the use of the rail trail does not impinge on private operations and that disputes are resolved wherever possible to the satisfaction of both the trail manager and the landowner. The on-going involvement with other sectors of the community will ensure that the trail is meeting their expectations.
-  **Trail user survey** – trail users will be surveyed on a bi-annual basis to ensure the trail is meeting their needs and expectations, and a survey of adjoining landowners and businesses will be undertaken to ensure the trail is meeting their expectations.

Due to the nature of a rail trail (a corridor surrounded by a range of activities), it can be vulnerable to the negative impacts of surrounding development. The Rails-to-Trails Conservancy (USA) suggests that trail planning include the development of a trail protection policy to prevent damage to the trail corridor. The policy sets out primary uses of the corridor – recreation, transportation, and historic preservation. Any use deemed incompatible with this primary use will be denied; those uses compatible with the primary use will be considered and carefully regulated.

A comprehensive **trail protection policy** provides the trail manager with the authority to do the following:

-  Regulate all secondary uses of the trail corridor in a fair and consistent manner;
-  Minimise inconvenience to trail users, and assure protection of wildlife habitat and natural and historic resources within the trail corridor;
-  Minimise damage to the trail corridor at all times;
-  Establish uniform standards for construction and restoration of the trail corridor if it is damaged by a secondary use;



-  Ensure that the managing agency recovers all its administrative costs and receives appropriate compensation for use of, and damage to, the trail corridor by secondary uses;
-  Inform all public and private interests of the expectations and intentions of the trail managing agency with respect to secondary uses;
-  Issue permits and licences for secondary uses; and
-  Prohibit the transfer of ownership rights through the use of easements or other mechanisms.

### 7.1.3 THE INITIAL DECISIONS

---

Some basic initial questions need to be answered, and some crucial decisions made. These inform the management decisions about the ongoing management of the rail trail. The following discussion covers the range of issues generally addressed in trail management. Questions are posed and some possible answers are included. These answers will need to be considered and more fully answered by the Council. Trailhead Code of Conduct signage should reflect the Council's position on the following matters.

#### ENFORCEMENT PROCEDURES

---

What enforcement procedures will be in place? The Council will have existing local laws covering a range of matters such as riding motorbikes in parks (a common issue). These local laws should form the basis for enforcement – the enforcement infrastructure is the key issue.

#### DOGS ON THE TRAIL

---

Will dogs be allowed? If they are allowed, in what sections should they be allowed? Will they be permitted to be off-leash, or will they be required to be on-leash? The proximity of dogs to other dogs on rural properties and to livestock on adjoining lands can cause an unacceptable conflict or public safety problem.

It is recommended that dogs should be permitted on the trail within the Maryborough town limit (out to Maryborough West trailhead). Fraser Coast Regional Council may determine to extend this boundary to be consistent with the existing trail at the Hervey Bay end of the corridor. Dogs would be permitted on leash and managed in accordance with relevant local laws.

#### HORSES ON THE TRAIL

---

Based on the survey and open house feedback, the Trail Development Plan has been prepared on the basis of horses using the section from Maryborough West trailhead to Piggford Lane. A provision has been made for the slashing of a separate bridle trail within the railway corridor or

trail alignment corridor (in the section between Aldershot and Churchill Mine Rd trailhead). It is proposed that horse riders use the existing vehicle track between Churchill Mine Rd trailhead and Stockyard Creek due to its availability thus reducing the costs. If 4WD vehicles and motorbikes continue to use this track once the trail is opened, Fraser Coast Regional Council should consider providing a slashed bridle trail within the rail corridor (this would come at a cost – both construction and maintenance though it would be relatively low at \$5/metre for initial slashing). On previous projects of this type, adjoining landholders have expressed concerns over biosecurity which can be exacerbated by horse use of the trail. This does not appear to be an issue with this trail.

#### WEED ERADICATION AND CONTROL

---

What will be the weed eradication and/or long-term control program? The options are grazing, slashing or using poisons. The Council will have an obligation to deal with weeds.

#### OPEN FIRES AND BARBECUES

---

Any lighting of open fires or barbecues at any time of the year should not be permitted along the rail trail.

#### TRAIL CONSTRUCTION AND INFRASTRUCTURE STANDARDS

---

This Trail Development Plan has recommended a range of infrastructure. This includes the level of development of parking at the trailhead, user information, on-trail signposting, facilities etc. Decisions need to be made as to whether a high or low standard of infrastructure will feature on the trail. This may also include timetables for ongoing enhancements or embellishment of infrastructure. A decision on standards to be adopted on a permanent basis has implications for ongoing trail maintenance.

#### STRATEGIES FOR THE PROTECTION OF NATIVE VEGETATION

---

Together with road reserves, railway reserves played an important role as wildlife corridors and habitats for native birds and animals. In many instances they hold important remnants of the indigenous vegetation that has been all but lost. It is important to manage railway reserves in a manner that maintains and enhances their nature conservation values.

In order to improve aesthetic and nature conservation values, the removal of introduced weeds and grasses and revegetation with native species is desirable. Revegetation is also important in some areas for visitor comfort. Any revegetation areas should be fenced off from stock and planted with native trees, shrubs, herbaceous plants and grasses. This has not been specifically costed in the works tables. Where screen planting is recommended (primarily for privacy purposes), appropriate native species should be used.

The assistance of dedicated volunteer groups will help ensure that revegetation programs are quickly implemented and successful.

Once the rail trail is developed, the Council will be responsible for management of revegetation and the control of weeds within the corridor.

### COMPLAINTS/COMMUNICATIONS – PROCEDURES AND RESPONSIBILITIES

It is critically important for the rail trail users, adjoining landholders and the public to have contact with authorities to ensure that the rail trail is managed properly, that maintenance matters are attended to readily, that any regulations are enforced and that general feedback can be given. It is important that this person or agency is easily contactable. Contact details need to be on all trail literature and maps, on trailhead signage, and on relevant websites.

It is important that the public and users know who to contact about the trail and about management issues. Responsibility rests with an accountable person or group. The Council needs to take responsibility for organising maintenance and for any necessary trail closures and for being the first point of contact for most matters.

It is strongly recommended that one person be allocated within Council to be the primary contact point for trail matters.

### ON-TRAIL EVENTS AND GROUP USE POLICY

One form of group usage is the on-trail special event and how these are to be managed. The Council should notify, and seek input from, local police and other emergency service personnel when any sizeable event is planned. It builds good community relationships. Major events not involving alcohol may also require assistance from police; for example, police are often involved with events, providing some traffic control services. It is good practice to involve local service personnel in the early stages of event planning.

### ON-TRAIL ADVERTISING

Will on-trail advertising be allowed? The Council needs to be aware that advertising can be an advantage to users and commercial operators, it should be controlled, it is a source of funding for ongoing



*Commercial establishments, such as accommodation providers, alongside the Otago Central Rail Trail in New Zealand are obliged to comply with advertising design guidelines and pay for the advertising.*

maintenance/upgrades, it should be to a standard, and style guides should be determined including rail trail logo. On-trail advertising is one avenue of revenue generation. The main impacts of such advertising would be visual impacts and safety impacts. Any permitted advertising signs should not impede trail users nor create a safety hazard (for example, by obscuring a road crossing warning sign). Visual impacts are much more difficult to judge. Local governments have a range of signage policies that are likely to address visual amenity. Policies that regulate road-side advertising would be the most relevant. Where these are not compatible, the Council should determine the criteria. On-trail advertising is likely to be directly connected to trail-side businesses (this could be one of the criteria) but the Council would not be endorsing the service nor directing trail users to that facility under any agreement.

#### TARGET USER GROUPS NEED TO BE IDENTIFIED

---

A promotion and marketing plan will need to be included in the set of initial decisions. Tasks will need to be allocated both in the initial stage and in ongoing trail development and operation.

The opening of the trail should be well advertised via local media (TV, radio, newspapers), throughout the Wide Bay Burnett region and in Brisbane. Opening events should be arranged to make potential users well aware of the existence of the new trail.

#### USE OF THE TRAIL CORRIDOR BY UTILITIES

---

A linear corridor such as a rail trail does lend itself to a range of potential future uses – many of which are not excluded by the possibility of the corridor being converted into a recreation trail. This former railway corridor, like so many others around the world, is also ideally suited for the placement of utilities, such as wires, cables and pipes. Data, telephony and energy can and are all carried in pipes alongside or underneath rail trails. These uses can be complementary to the corridor's use as a recreation trail.

Provided the intended co-use does not disturb the natural, scenic and historical qualities of the trail, it can be permitted in accordance with the Trail Protection Policy (discussed in Section 7.1.2). In other jurisdictions, utilities are charged an annual fee for corridor use.

#### CONSIDERATION AND AMELIORATION OF IMPACTS ON ADJOINING LANDHOLDERS

---

This covers issues such as fencing, privacy issues, trespassing, the rights to use the corridor for agricultural purposes (notably the turning of machinery), who will pay for construction works that allow farmers to continue activities etc. The Corridor Management Plan needs to set a basis for how these are dealt with on an on-going basis. One of the guiding principles for the Mary to Bay Rail Trail should be that the management and maintenance of the trail will consistently seek to involve the local community on an on-going basis and in the formulation of critical decisions. This on-going involvement with adjoining landowners and the community will

ensure that the use of the rail trail does not impinge on private operations and that disputes are resolved wherever possible to the satisfaction of both the trail manager and the landowner.

A spirit of cooperation with adjoining landholders needs to be continued throughout the life of the rail trail. Building community support is critical – adjoining landholders can provide a significant boost for wider community support. There are no rules for on-going engagement with adjoining landholders – a willingness to sit down and listen and discuss openly is required. Having a single contact point for the trail would be a significant advantage to ensure ongoing good relationships with landholders. Inviting landowners to ‘adopt-the-trail-section’ adjacent to their property may be warranted.

## MANAGEMENT STRUCTURES AND MANAGEMENT PLANNING

---







Decisions about management structures, timetables for change and the reasons for decisions should also be included in the Corridor Management Plan. Ongoing community involvement which will be driven through the management structures needs to be also included in the Corridor Management Plan – the why, the how and the who need to be clearly articulated in an accessible document.







---

### 7.2 A TRAIL MANAGEMENT PLAN

A Trail Management Plan is essential to setting both the long-term and day-to-day management objectives for the trail and provides a framework against which a range of decisions can be made. Such a document - as with all management plans - should be both flexible and responsive to change yet set a clear management framework for future directions and priorities. Trails that do not have a Management Plan suffer from decisions taken on the run, out of context or as knee-jerk responses to critical situations.

The trail manager (Shire of Mundaring) for the Railway Reserves Heritage Trail (RRHT) in Western Australia prepared a Trail Management Plan several years ago. It is a useful model to consider the issues that need to be dealt with by a Trail Management Plan. The issues covered were:

-  Philosophical background to RRHT development;
-  A statement of guiding principles;
-  Review of how RRHT is, and can be further linked to other trails, especially the Munda Biddi Trail, the Bibbulmun Track, the Kep Track, the Farming Heritage Trail and those in the eastern portion of the City of Swan.
-  Clarification of management roles and responsibilities for the various trail sections;
-  Risk management policy;
-  Group and commercial usage policy and guidelines;

-  Provision of essential services for trail users, such as water points, toilets, rubbish bin, lighting and other desirable trail furniture;
-  Identification of any outstanding access /egress works for the RRHT, including disability works;
-  Fire management and emergency evacuation procedures;
-  Preparation of a promotional and interpretation management sub-plans, including specifications for signage and suggestions for interpretation along the trail between the townsites;
-  Mapping and brochures – guiding principles;
-  Formation of a Friends of the RRH Trail Group; and
-  Timetable for reviewing and updating the Management Plan

Some of the initial decisions mentioned above flow into a trail management plan and should be included.





A timetable for reviewing and updating this Plan should be set, with annual reviews and three (or five) year updates recommended. The Plan must outline a professional program of management, designed to ensure that there is no lapse into a belief that trails, once built, will manage themselves.

Further, this plan must clearly define who is responsible for what – it is crucial that everyone knows what their role and responsibility is. Without this, it is all too easy for everyone to sit back expecting someone else to do the work. Trail management plans need to be specific about roles in management and maintenance.

---









### 7.3 GENERAL RISK MANAGEMENT

A risk is the chance of something happening as a result of a hazard or threat that will impact on an activity or planned event. Risk arises out of uncertainty. It is measured in terms of the likelihood of it happening and the consequences if it does happen. Risk therefore, even on trails, needs to be managed. Ignoring the risks that apply to a recreation trail or events planned along a trail could impact on:

-  The health and safety of trail users, staff, volunteers and event participants;
-  The reputation, credibility and status of the trail and its manager (or trail association);
-  Public and customer confidence in the trail manager;
-  The trail manager's financial position; and
-  Plant, equipment and the environment.











A systematic approach to managing risk is now regarded as good management practice. Risk management is a process consisting of well-defined steps which, when taken in sequence, support better decision making by contributing to a greater insight into risks and their impacts. It is as much about identifying opportunities as it is about avoiding losses. By adopting effective risk management techniques, the trail manager can help to improve the safety of trail users, the quality of experience for trail users and business performance of the trail organisation. Sound risk management can prevent injuries from occurring and help to reduce insurance claims and costs. Risk management is of particular importance to nature based and adventure tourism operations and requires careful consideration in how it is planned for and dealt with. The courts expect that a business (including local governments) will exercise due diligence in carrying out hazard assessment, risk management planning and emergency response planning. There are many benefits in implementing risk management procedures. Some of these include:

-  More effective strategic planning;
-  Better cost control;
-  Increased knowledge and understanding of exposure to risk;
-  A systematic, well-informed and thorough method of decision making;
-  Increased preparedness for outside review;
-  Minimised disruptions;
-  Better utilisation of resources;
-  Strengthening culture for continued improvement; and
-  Creating a best practice and quality organisation.

Though the rail trail would be located on a reasonably flat grade, and is wide enough to accommodate several user groups, there will be risks associated with use of the trail.

Some of the risks involved are:

-  Encountering motor vehicles at road crossings;
-  Conflict between user groups;
-  Encountering illegal trail users such as cars/4WD and trail bikes;
-  Falling from unprotected bridge crossings (though handrails on all bridges over 1 metre high would be required);
-  Falling from high embankments, where there are no barriers;
-  Being caught in a grass fire;
-  Being caught in a flood; and
-  Being bitten by a snake.

Good design and construction address some of these risk elements. Many trail projects have in place a maintenance plan which sets out clearly the items which require regular inspection, the frequency of that inspection and assessment, the actions to take in response to degraded surface conditions or infrastructure, and remedial action to rectify a problem or fault.









The threat of fires and floods is always present. Though snakes are rarely encountered, it may be prudent for trail promotional material to carry a warning about possible encounters and to provide information about dealing with a snakebite.

---

## 7.4 AN EMERGENCY RESPONSE PLAN

Major fire events throughout Australia in recent years have put the need for emergency planning and management into sharp focus. Trail managers need to be very conscious of the need to prepare emergency response plans and work out how to deal with emergencies on trails. This is not limited to fires. Flooding can be just as serious an issue.

The key elements of an emergency response plan for a rail trail such as this are:

-  General risk management;
-  Fire risk and fire management;
-  Flood risk and evacuation procedures;
-  The provision of appropriate signage;
-  Trail access for emergency service vehicles;
-  Emergency responses – how and who;
-  The provision of adequate information and mapping to the services' communications centres;
-  The need for special agreements between emergency service providers and the trail manager; and
-  The provision of on-trail communication systems.



---

### 7.4.1 FIRE RISK AND MANAGEMENT





The trail manager will be responsible for implementing fire protection and management along the rail trail corridor to protect life, property, public assets and natural and cultural values from fire, reduce the incidence of fire, reduce the severity and restrict the spread of fire. The aim of fire management is to ensure trail users and adjoining landholders are protected from fire commencing on or travelling along the rail trail corridor. To reduce the incidence of fire starting from the rail trail all open or solid fuel fires should be prohibited. At visitor facilities, such as trailheads, picnic shelters and rest areas, slashing should be used to reduce fuel loads. Where the corridor has tree cover or where revegetation is to occur, there will be a need to provide a buffer zone along the boundary or alternatively seasonal grazing of the vegetated area to

reduce fuel loads will be permitted. Relevant signage at trailheads needs to include fire warnings.

Fire management issues include:

-  Fire risk factors in the area – risk profile is influenced by a number of factors including slope of the land (hilly terrain and north and west facing slopes increase risk), response time for emergency vehicles (the closer to a town a trail location, the less time for emergency vehicles to get there), proximity of roads and how heavily trafficked they are (highways and major arterials increase risk due to higher numbers of passing motorists), and closeness of refuges including fire-proof buildings and roads.
-  Fire management responses for the trail. These included closure on days of total fire ban (and consequent policing). This is now done regularly in National Parks throughout Australia and on recreational trails. Mapping technology may be available that provides good indicators as to fire paths which would allow parts of the trail to be ranked in terms of fire risk (recognising that nothing can be absolutely precise). Possible management responses in zones of highest fire risk may include appropriate warnings, and possible longer closures on these sections (rather than just on days of total fire bans). Sections of trail in zones of lower fire risk could have a lower level of fire management response.
-  The banning of smoking on the rail trail under legislation governing smoking in outdoor areas. It is acknowledged that this is difficult to enforce except by having a constant presence; it is however a possible ‘tool in the toolbox’ for managing fire risk.



It is of major importance to develop a Bush Fire Risk Management Plan early in the planning process in consultation with the Qld Fire and Emergency Services. This is an issue with many rail trails (and in fact with any activity that takes people out into the bush in significant numbers). It has been successfully tackled elsewhere. For example, the Lilydale to Warburton Rail Trail (in Victoria) has developed a Wildfire Risk Management Plan. The Plan includes a number of objectives and relevant actions. The objectives are:

-  Providing a safe recreation trail for walkers, cyclists and horse riding;
-  Providing a safe access onto and along the trail for all emergency vehicles;
-  Minimising the risks of fires spreading from or onto the rail trail; and
-  Developing annual maintenance works and maintenance programs (with an accent on fire hazard reduction).

### 7.4.2 FLOOD RISK

---

Flood issues include:

-  Need for safe crossing of all waterways.
-  Closing the trail, or sections of the trail, at times of flooding (or immediately after heavy rains when the trail surface may be impacted by trail users).
-  Evacuation procedures when trail users are inadvertently caught on the trail during a sudden flood event.

### 7.4.3 APPROPRIATE SIGNAGE

---

Trailhead signage should specify what to do in an emergency, the numbers to call, the location of public phones, and the capacity for a flip-down sign indicating trail closure (due primarily to fire, flooding or maintenance work).

Many trails, including rail trails, are now using Emergency Marker signage placed at regular intervals along the trail and at road crossings.

The Emergency Marker system generally uses a unique alpha-numeric code for each location. The trail would have a series of consecutively numbered sign posts. The signs contain not just the unique alpha-numeric identifier, but also the Emergency telephone number to call for help. Emergency Service operators are aware of the location of each uniquely identified sign and can send help to that specific location in an emergency.

### 7.4.4 TRAIL ACCESS FOR EMERGENCY SERVICES

---

The main design element is that emergency vehicles will need to have access to the rail trail. The simplest option is to ensure that all locked management gates along the trail (such as recommended for all road crossings) and alongside adjoining roads have the same locking system, either key or combination locks. The preferred option is a combination lock. A single combination for an entire trail is recommended; this can be registered with the communications centres of each of the emergency services, which dispatch vehicles to emergencies.

### 7.4.5 EMERGENCY RESPONSES – WHO AND HOW

---

In an emergency situation, one of the key issues that arise is how an emergency is communicated. The emergency number from a landline is 000, while the emergency number that works best from a mobile phone is 112. Once a call is made by a trail user, the communications centre for the appropriate service dispatches the required personnel and vehicles. The trail manager would only likely to be involved after the emergency situation is resolved, to review and record the incident, and to review the response.

It is a different situation when the emergency is a slowly emerging situation, such as a period of total fire ban (or very high fire risk) or the likelihood of flooding. The trail manager needs the vested authority to close the trail under such circumstances (under relevant state government legislation). Once the trail manager advises police that the trail (or part of the trail) is closed, police have the powers to ensure that people do not go onto the trail or can be removed from the trail if they are on it (an administrative trespass) though most people accept the advice of police. In an emergency such as a fire or flood (as opposed to trail closure because of a fire risk for example), emergency services have ‘command and control’ powers that allow them to remove people from a situation considered to be dangerous. In such circumstances, emergency service personnel are ‘out and about’ and see people and move them to an appropriate place.

At times when the trail needs to be closed (such as a very high fire risk or when flooding of watercourses is present), police would be able to travel to trailheads in their area and ‘flip down’ the Trail Closed sign.

#### 7.4.6 PROVISION OF ADEQUATE INFORMATION FOR COMMUNICATIONS CENTRES

---

As the trail develops, mapping data should be provided to the communications centres for each of the emergency services. The data that should be entered into their system covers maps with the location of Emergency Markers, trail distance markers (and their reference points), and road crossings (and their GPS coordinates) marked on the maps. One set of data should be developed and given to all the communications centres.

#### 7.4.7 SPECIAL AGREEMENTS

---

There is usually no need for special formal arrangements between the trail manager and the emergency services for a trail. It is a resource and an activity that the emergency services need to deal with as part of their everyday activities. Any major events on the trail should trigger early involvement by police and ambulance in particular – this is good practice and ensures good relationships.

#### 7.4.8 ON-TRAIL COMMUNICATIONS SYSTEMS

---

The placement of emergency phones on the trail as a way of ensuring that emergencies could be managed could be considered. However, this is a significant cost item to install, replace and maintain. In addition, most trail users would have some form of mobile phone. In addition, placing phones on the trail possibly increases the trail manager’s liability – if a phone does not work (for instance it is broken), an aggrieved person may look for recompense from the trail manager. Public phones are often quite accessible from trailheads and their locations should be shown on all trail mapping (brochures, trailheads, Web sites etc.).

---

## 7.5 A TRAIL MAINTENANCE PLAN

*(This material was partially covered in the Feasibility Report but is covered in more detail below)*

---

### 7.5.1 INTRODUCTION

Ongoing trail maintenance is a crucial component of an effective management program – yet it is often neglected until too late. Countless quality trails have literally disappeared because no one planned a maintenance program and no one wanted to fund even essential ongoing repairs. It is therefore essential that funds be set aside in yearly budgets for maintenance of this trail - to ensure user safety and enjoyment, and to minimise liability risks for land managers.

---

### 7.5.2 THE MAINTENANCE TASK



Ongoing maintenance can be minimised by building a trail well in the first place. A well-constructed trail surface will last considerably longer than a poorly built trail. Signs, gates, and posts installed in substantial footings stand less risk of being stolen or damaged. Well designed, well-built and well installed management access gates and trail user gates (as proposed) will keep motor vehicles and motorised trail bikes off the trail with a consequent lessened need for surface repairs. Trail furniture (such as bench seats, trail directional marker posts and interpretation) should be installed in substantial footings sufficient to withstand high winds and theft. These should require minimal ongoing maintenance. Vehicles moving along a sealed pathway (as proposed for Maryborough to Maryborough West) have the capacity to crack the surface if tyres sit on the trail edge. Care needs to be taken by maintenance vehicles.

The presence of trees along some of the trail means that time will be spent removing damaged and fallen trees and branches in the aftermath of a storm.

The most frequent maintenance task will be attending to fallen branches and limbs, repairing trail surfaces, replacing stolen or damaged signs (including road signs), clearing culverts and under bridges and ensuring gates and fences are functioning as intended.

As noted above, building good trails in the first place is the very best way of minimising future problems and costs. As a second line of defence, a clear and concise Management Plan with a regular maintenance program written into it will aid significantly in managing ongoing resource demands.

The goals of a Trail Maintenance Plan are to:

-  Ensure that trail users continue to experience safe and enjoyable conditions;
-  Guard against the deterioration of trail infrastructure, thereby maintaining the investment made on behalf of the community;



- ✚ Minimise the trail manager’s exposure to potential public liability claims arising from incidents which may occur along the trail; and
- ✚ Set in place a management process to cover most foreseeable risks.

Erosion (caused by weather and unauthorised users), regrowth of vegetation (including grass and weeds on the trail corridor but not on the trail surface), fallen trees and branches, and damage to signage and fences are likely to be the greatest maintenance activities on the trail. Providing these effects are attended to early, they are largely labour intensive rather than capital expensive. Calamitous events such as fire or major flood will naturally generate significant rebuilding activity and consequent costs. These events are generally unmanageable and should simply be accepted as part of the longer-term reality of trail management.

### 7.5.3 PUBLIC LIABILITY AND RISK MANAGEMENT

---

It is important that Fraser Coast Regional Council is aware that – whether or not visitors are actively encouraged to come to the trail – they carry a significant duty of care towards those visitors accessing the trail. The maintenance of a quality trail is therefore critical from this perspective. Liability generally rests with the land managers and hence, every attempt should be made to minimise the risk of accident or injury to trail users (and therefore the risk of legal action).

While public liability is certainly an issue for all land managers, it is not a reason to turn away from providing safe, sustainable and enjoyable resources. It is simply a mechanism by which to recognise the responsibilities inherent in managing natural and built resources. Dealing with a perceived liability threat is not about totally removing that threat – it is about doing all that is manifestly possible to provide safe access opportunities for visitors, thereby minimising the risk of liability claims.

A formal Hazard Inspection process is crucial in the ongoing maintenance plan. Not only will this define maintenance required and/or management decisions to be addressed, it is vital in ensuring safe conditions and therefore in dealing with any liability claim which may arise in the future. Courts are strongly swayed by evidence of a clear and functional program, and a regular series of reports, with follow-up actions, will go a long way to mitigating responsibility for injuries. Further, clearly defined ‘User Responsibility’ statements in brochures, maps, policy documents, plans and public places will assist this process.

### 7.5.4 TRAIL MAINTENANCE

---

The following information is provided as general maintenance guidance. An inventory of works and locations needs to be prepared for maintenance purposes – this cannot be prepared until construction is completed. An example of a checklist for a trail is included in Appendix 4. The

Council will need to create a specific checklist based on this example once the trail is completed.

Maintenance on the trail should be divided between regular inspections and simple repairs, a one (or two) person job, and quarterly programs undertaking larger jobs such as significant signage repairs or weed / vegetation control. A range of basic machinery, tools and equipment will be required for this work.

At the core of any trail maintenance program is an inspection program. The relevant Australian Standards sets out the basis for frequency of trail inspections. It only covers walking tracks and provides for inspections every 30 days (or less) for Class 1 trails, every 90 days for Class 2 trails, and annually for Class 3-6 trails. This sets the minimum standard for inspections and is a guide only. What the Australian Standards do not include but should include is an inspection of any trail after significant weather events such as storms, fire, floods, and high winds in addition to the regular inspection program. The proposed inspection regime recommends inspections every 90 days.

Clear records of each activity/inspection will be kept by the body with responsibility for maintenance. Pro-formas serve to maximise user safety and minimise liability risks. It will also provide a valuable record of works undertaken and make for efficient use of maintenance resources over time.

In general, Maintenance Plans are based around regular inspections, at which time simple maintenance activities should take place concurrently. More time-consuming maintenance activities should take place every six months, while detailed Hazard Inspections should occur annually. Further, the capacity to respond immediately to random incoming reports of hazards or major infrastructure failures should be built into the Plans. Table 9 gives a suggested schedule for general maintenance activities to achieve acceptable maintenance levels and provides explanatory notes pertaining to each Activity.

**Table 9: General Maintenance Activities**

<i>Activity</i>	<i>Activity Description</i>	<i>Site</i>	<i>Frequency</i>
Undertake full inspection of the trail.	<p><b>At Trailheads</b></p> <p>The trailhead should be carefully checked to ensure that all signage is present, and that all signs are clearly visible and legible. An inventory needs to be prepared to assist in regular maintenance.</p> <p>Surface of access tracks and parking areas need to be checked and potholes eliminated.</p> <p>Inspect and check trailhead facilities and infrastructure:</p> <ul style="list-style-type: none"> <li>○ Parking areas and access tracks (check surfaces)</li> <li>○ Bollards</li> <li>○ Trailhead (map) panel</li> <li>○ interpretive panel</li> <li>○ Seating/shelter/picnic tables</li> <li>○ Trailhead signage (on road)</li> <li>○ Trail directional marker posts</li> </ul> <p><b>At Road crossings</b></p> <p>Particular attention needs to be given to signs at road crossings or junctions. Each crossing should be carefully checked to ensure that all signage is present, and that all signs are clearly visible. Particular attention must be given to ensuring that “Trail Crossing ahead” signs (on roadside at approach to trail crossing) are not obscured by overhanging vegetation.</p> <p>Replace damaged and/or missing signs.</p>	Entire trail	Every third month

	<p>Check management access gates and trail user chicanes for structural stability and function.</p> <p><b>Fencing</b></p> <p>Check and make repairs to side fencing. To be done by arrangement with adjoining landowners where appropriate.</p>		
<p>Check signage and clean, replace or repair as required esp. road crossing signage and directional markers. All signage should be checked for vandalism and cleaned if necessary. If damage is too great, replacement is essential.</p> <p>An inventory of locations of all signs needs to be prepared to assist in regular maintenance.</p>	<p>Check, repair or replace all trail signage, including interpretive signage, trail distance and directional markers (logo/arrow plates). Replace missing and/or damaged signs.</p>	<p>All locations</p>	<p>Every third month - at each trail inspection</p>
<p>Slashing of trail environs.</p>		<p>Various locations</p>	<p>Timing dependent on seasonal growth patterns</p>
<p>Check trail surface and arrange repair as required.</p>		<p>Entire trail</p>	<p>Every third month. Arrange repairs immediately if acute, or schedule maintenance for six monthly work sessions if not.</p>

Maintenance of trail surface.	Check condition of trail surface for damage and arrange repairs if necessary; trim off regrowth vegetation.	Entire trail	Every six months
Sweep or rake debris from trail surfaces, especially at road crossing points.		Various locations	Every six months
Maintenance of culverts and other drainage measures.	<p>Check and clear drains and culverts. Drains need to be checked and cleared once or twice/year and after heavy rainfall events. Regular maintenance especially after heavy rainfall is essential.</p> <p>Most maintenance will involve clearing of material from silted up or blocked drains.</p> <p>Drain blockages should be cleared as urgent priority.</p> <p>Silt traps at culvert discharges or entry points should be cleared regularly.</p> <p>Cess drains in cuttings should be checked to ensure they function effectively.</p>	Entire trail	Every six months
Cut back regrowth, intruding and overhanging vegetation.	<p>Check overhanging or intruding vegetation. Cut back where required. Clear fallen trees and branches.</p> <p>Undergrowth vegetation grows quickly, and over time will continue to intrude into the trail 'corridor'. Such intruding vegetation needs to be cut back to provide clear and safe passage for trail users.</p> <p>"Blow-downs" - trees or limbs that have fallen across the trail – need</p>	Entire trail	Every six months, unless obviously requiring attention at regular inspections.

	<p>to be cleared as/when required. Sight lines must be kept clear either side of road crossings, to ensure that users can clearly see a safe distance either way at road crossings.</p>		
<p>Check structural stability of interpretive signage, and interpretive shelters. Check structural stability of seating, distance posts. Inspect and replace when needed.</p>	<p>Interpretive panels should be checked for vandalism and cleaned if necessary. If damage is too great, replacement is essential. An inventory of locations needs to be prepared to assist in regular maintenance. Furniture alongside trails, if installed, needs to be checked regularly for damage to ensure safety and comfort of trail users.</p>	<p>Entire trail</p>	<p>Every six months</p>
<p>Undertake Hazard Inspection and prepare Hazard Inspection Report.</p>	<p>This should be done annually. Inclusion of a formal Hazard Inspection process, crucial in addressing risk, is necessary in the ongoing maintenance plan. Not only will this define maintenance required and/or management decisions to be addressed, it is vital in ensuring safe conditions and therefore in dealing with any liability claim which may arise in the future. Courts are strongly swayed by evidence of a clear and functional program, and a regular series of reports, with follow-up actions, will go a long way to mitigating responsibility for injuries. Further, clearly defined 'User Responsibility' statements in brochures, maps, policy</p>	<p>Entire trail</p>	<p>Annually</p>

	documents, plans and public places will assist this process.		
Check structural integrity of bridges. Inspect and maintain bridges. Check for obstructions and clearing under bridges.	Visual inspection is appropriate though detailed inspection should follow storm and flood events. After floods, bridge should be inspected and damaged components replaced as soon as possible. Handrails and surface decking on bridge should be inspected for damage at regular intervals.		Annually
Major repairs and replacements		Entire trail	Every 5 years
Major repairs and replacements		Entire trail	Every 10 years

*It should be noted that this schedule does not allow for repair works above and beyond 'normal' minor activities. For example, if a section is subject to heavy rain, and erosion control fails, additional repair works will need to be undertaken.*

### 7.5.5 MAINTENANCE COSTS

*(General costings were discussed in detail in the Feasibility Report. The information below is more specific to this trail).*

Resourcing a maintenance program is crucial, and funds will be required on an ongoing basis to enable this essential maintenance. It would be short sighted to go ahead and build the trail and then balk at the demands of managing and maintaining it.

The biggest maintenance costs involved are obviously maintenance of the items that initially cost the most to install – surfacing and bridges (though use of a sealed surface reduces the maintenance load, as will the use of pre-fabricated bridges).

It is difficult estimating the costs involved in maintaining a trail until every last bridge and other infrastructure items have been installed.

The use of volunteers to undertake many of the routine repairs and cleaning tasks can substantially reduce the costs.

Table 10 makes an attempt at estimating an amount that may be required on an annual basis for maintaining the proposed Mary to Bay Rail Trail (covering only the sections from Maryborough to Walligan Trailhead, and from Piggford Lane to Nikenbah).



Table 10: Estimate of Maintenance Costs (Mary to Bay Rail Trail – 33.9 km)

<i>Task</i>	<i>Frequency/note</i>	<i>Possible costs</i>
Inspect and check trailhead facilities and infrastructure: <ul style="list-style-type: none"> <li>○ parking areas (check surfaces)</li> <li>○ bollards</li> <li>○ interpretive panel</li> <li>○ picnic tables</li> <li>○ trailhead signage (on road)</li> <li>○ trailhead (map) panel</li> <li>○ trail directional marker posts</li> </ul>	Average repairs of \$700 per site (6 trailheads including Walligan).	4,200
Trail surface - allowance for incidental repairs to, and upgrading of, trail surface.	Allowance of 2% of replacement cost (i.e. 2% of \$2,884,175).	57,680
Check side vegetation growth and overhead vegetation and cut back where required. Clearing of fallen trees and branches.	Allowance of 6 person days per year (@ \$500/day).	3,000
Slashing of trail environs.	Allowance for 10/year.	20,000
Inspection and routine maintenance of bridges (all timber components, decking, handrails, etc.). Check for obstructions and clearing under bridges.	Allowance of \$30/m/year for timber bridges (3), \$800 per year for new installations (10 bridges).	13,000
Repair and replacement of fencing (all types).	Allowance for 2% per year of replacement cost.	18,000
Check and clear culverts.	Allowance of 30 hours for checking and cleaning.	3,000
Check road crossings. Replace damaged and/or missing signs and undertake other tasks:	5 crossings at average repairs of \$300 per crossing.	1,500

<ul style="list-style-type: none"> <li>○ Give Way signs</li> <li>○ Road Ahead signs</li> <li>○ Trail Crossing warning signs</li> <li>○ Road name signs</li> <li>○ Regulatory signs</li> <li>○ Check sight distances and clear vegetation if necessary.</li> </ul>		
Inspection of and allowance for replacement of trail directional marker logo/arrow plates and trail kilometre posts.	3 replacements per year.	1,800
Allowance for repairs to trailside furniture and occasional replacements (when required).	Inspection and minor repairs every 6 months. 1 replacement per year.	2,000
Check regulatory signs along trail (e.g. Road Ahead, Give Way, trail name, distance signs, “No Trespassing”, bridge load signs, etc).	Allowance for 10 replacements per year.	3,000
Check management access gates, chicanes and fences at road crossings. Make repairs where necessary.	Allowance of \$6,000 per year for repairs.	6,000
Check interpretation along trail for damage and structural stability.	Allowance for replacement of 2 panels per year.	6,000
Check miscellaneous items (such as bollards, side fencing, screen planting)	Allowance for repairs and/or replacement.	6,000
Check miscellaneous (advisory / warning) signs along trail (e.g. Agric Vehicles Operating, No Trespassing, pictograms at crossings etc).	Allowance for 10 replacements per year.	2,000
Inspection of rail trail (3 times/year).	Allowance for 3 inspection trips per year.	7,500
Preparation of annual Hazard Inspection Report.	3 person days @ \$1,000/day.	3,000
<b><i>\$157,680 excl GST (per annum)</i></b>		

This equates to a rate of **approximately \$4,650** per kilometre per annum.

**Notes on Maintenance Program:**

*Reporting of routine maintenance requirements by trail users will obviate the need for many scheduled inspections.*

*Appointment of a Trail Manager, with responsibility for regular inspections of the entire trail, will substantially reduce the need for unscheduled and expensive maintenance.*

*Little maintenance will be required on newly built trail surfaces, bridge structures and other elements of the rail trail for several years after construction. Good asset management practice suggests money be put aside every year for maintenance, even though much of it will not be spent in the first 5-10 years as there will be limited need for maintenance.*

*36% of the maintenance budget is surface repair. The maintenance budget includes an annual allocation, but it should be noted that there will be very limited need for surface repairs in the first 5 years.*

*An allowance is also included for bridge maintenance – bridges are even less likely to need repair for the first 5 years (or even 10 years) of a trail's life. Re-constructed and refurbished bridges will require little or no maintenance for many years. However, after perhaps a decade of use they will require more and more maintenance of decking timbers (if used) and more scrutiny of fixings (depending on what materials are used for decking). Pre-fabricated bridges require less maintenance over time.*

*Maintenance on the two critical elements (surface and bridges) is even less likely to be needed in the first 5-10 years if the trail is built well in the first place. The key message is spend more on construction and spend less on maintenance.*

*The likely maintenance costs in the first few years of a trail's life will focus on sign damage and inspections.*

*Costings are at full commercial rates (but of course this would be far less if volunteers are involved). US evidence suggests significant savings using volunteer maintenance (trails maintained by volunteers costs one-third of those maintained by Government entities).*

**APPENDIX 1 – ROAD CROSSING DRAWINGS**

# MARY TO BAY RAIL TRAIL

## ROAD CROSSING CHURCHILL MINE ROAD

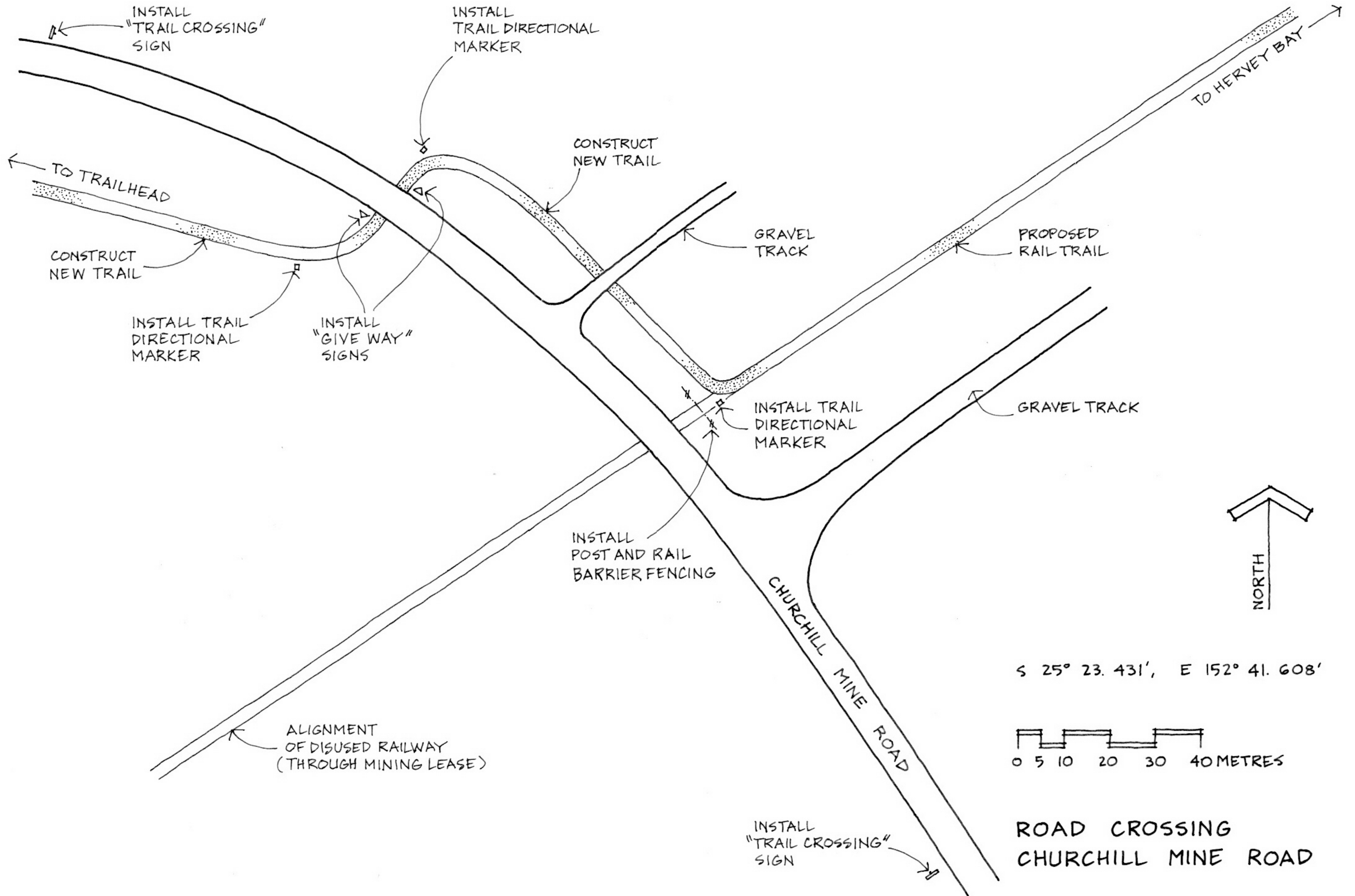



MARY TO BAY RAIL TRAIL  
ROAD CROSSING  
TORBANLEA PIALBA ROAD

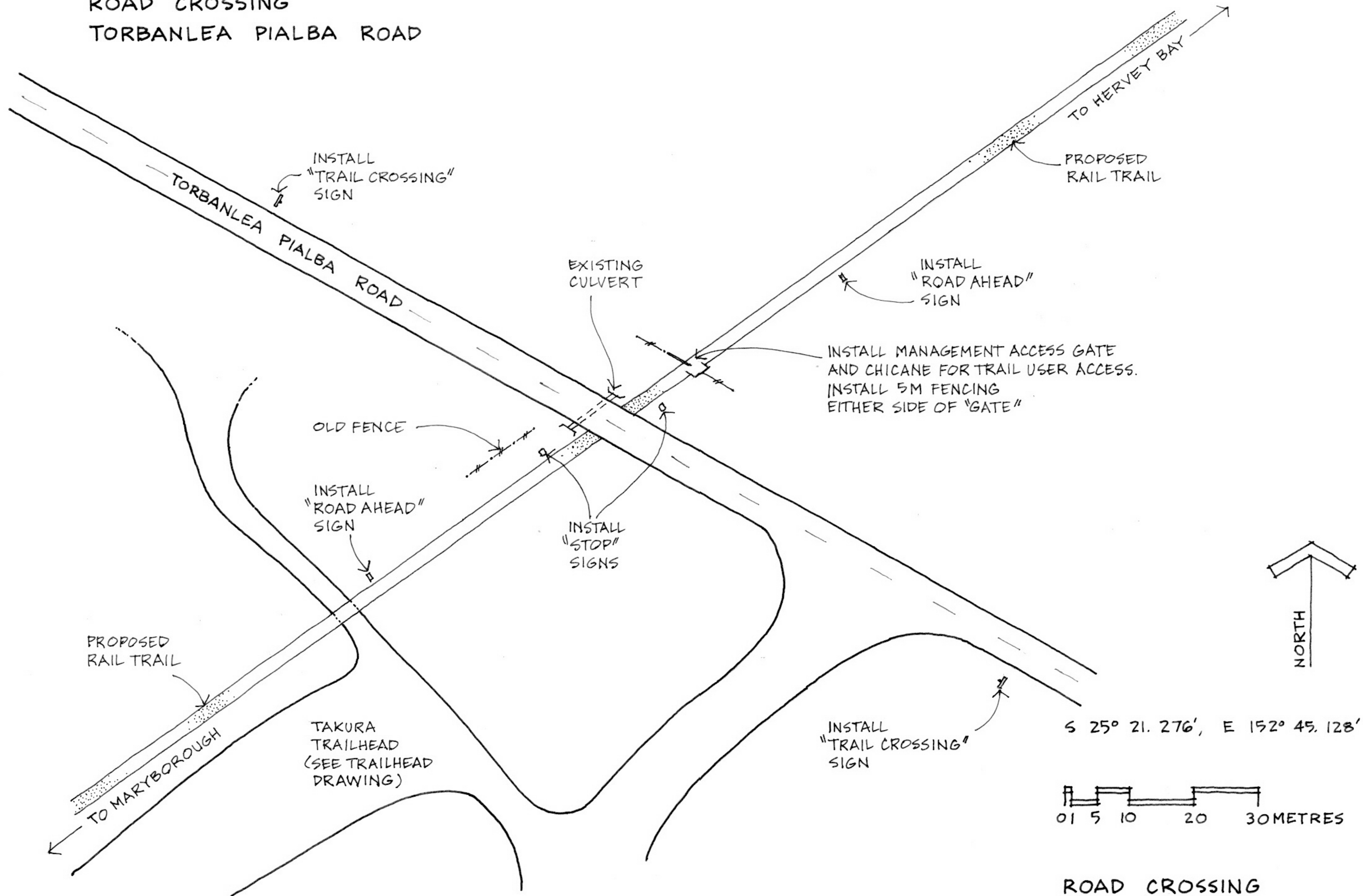

S 25° 21. 276', E 152° 45. 128'

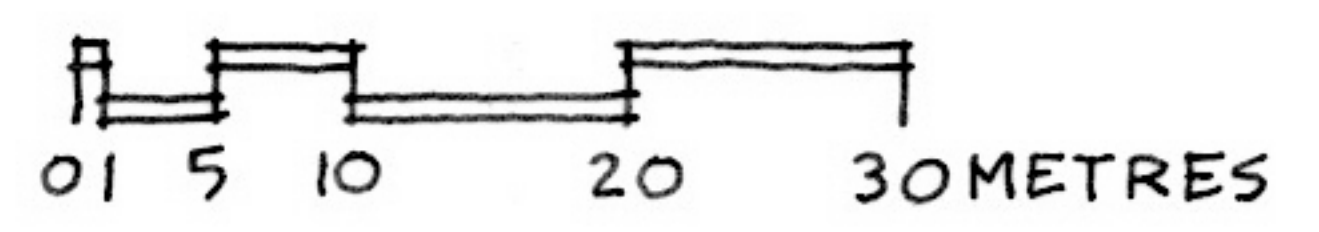

ROAD CROSSING  
TORBANLEA PIALBA ROAD

# MARY TO BAY RAIL TRAIL ROAD CROSSING DUNDOWRAN ROAD

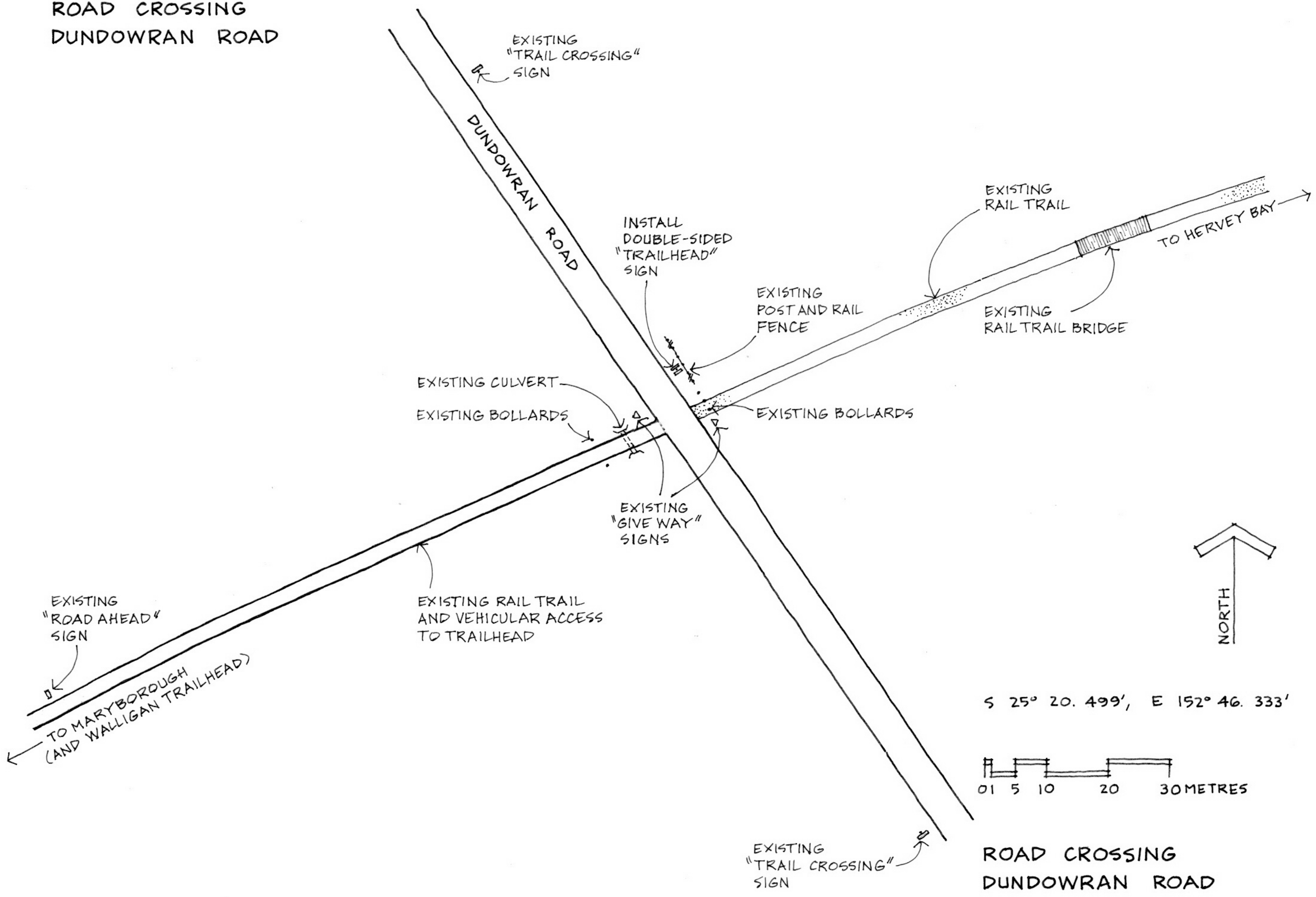



MARY TO BAY RAIL TRAIL  
ROAD CROSSING  
PIGGFORD LANE

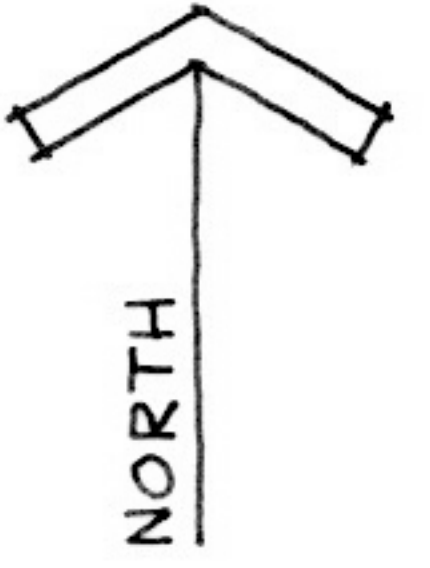

S 25° 19. 629', E 152° 47. 682'

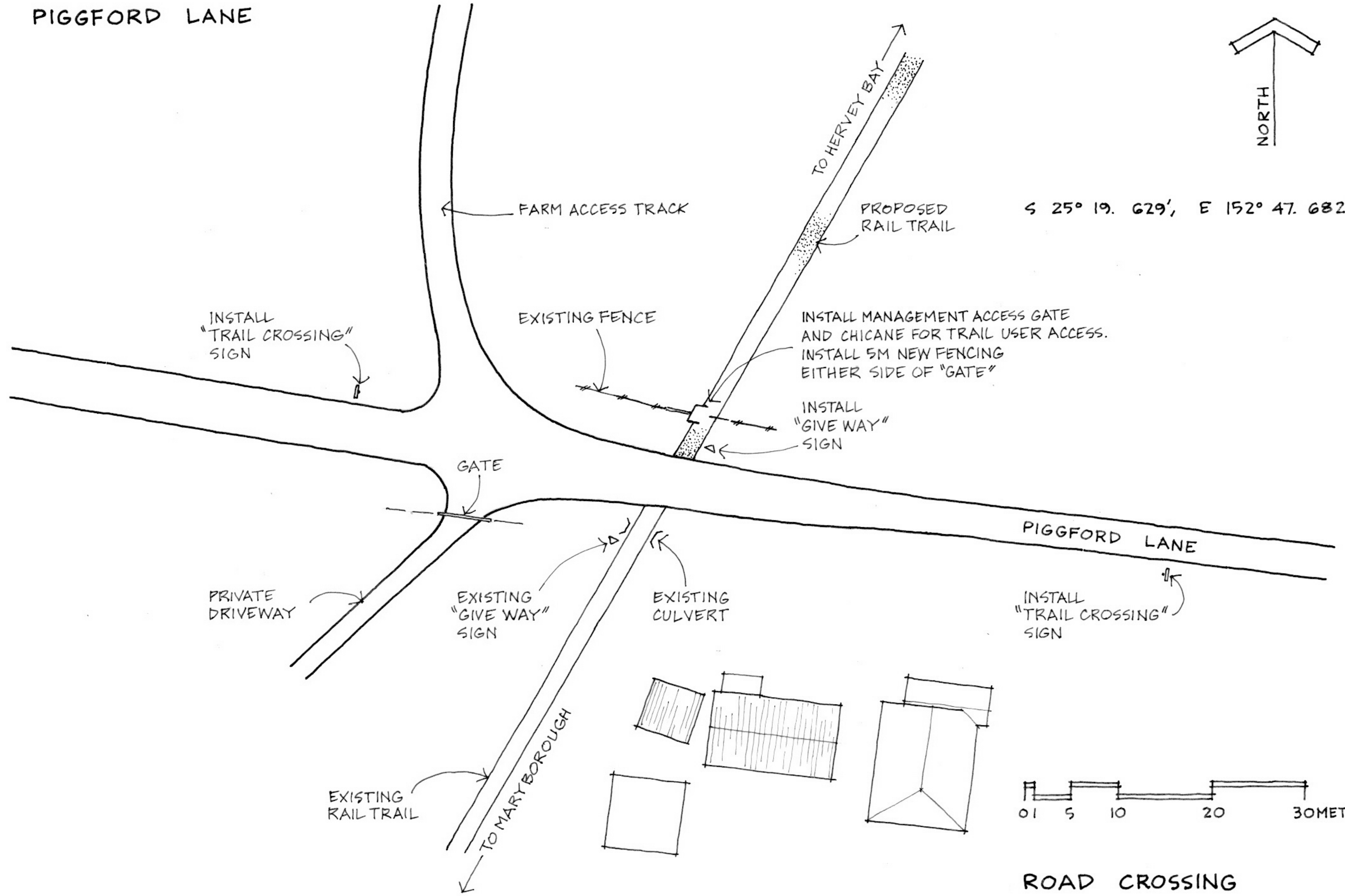

ROAD CROSSING  
PIGGFORD LANE

**APPENDIX 2 – CROSS SECTIONS AND PHOTOS – GATING SYSTEMS**

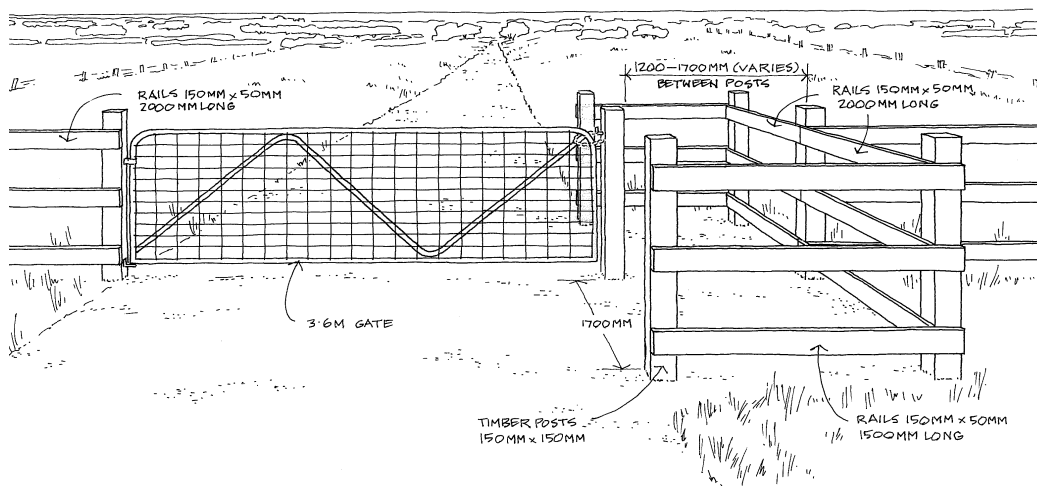

TYPICAL MANAGEMENT ACCESS GATE AND CHICANE

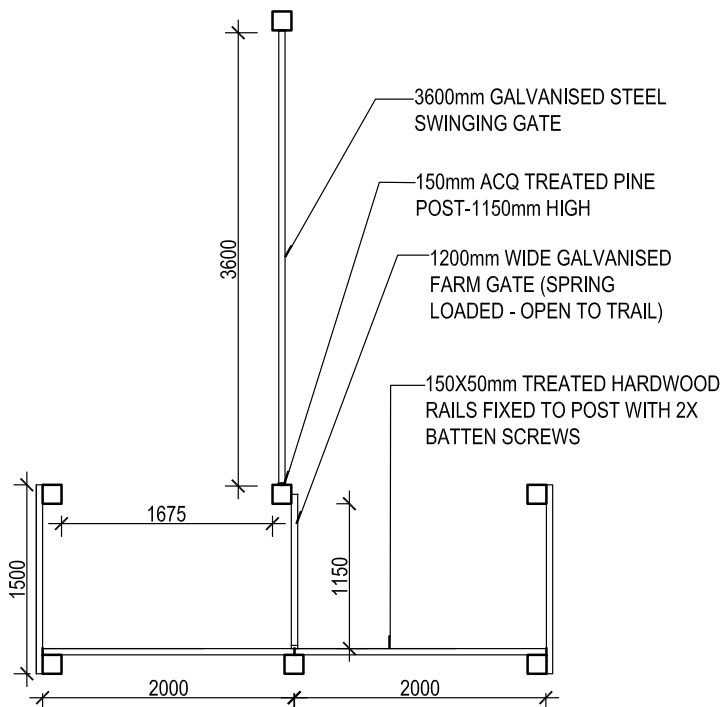
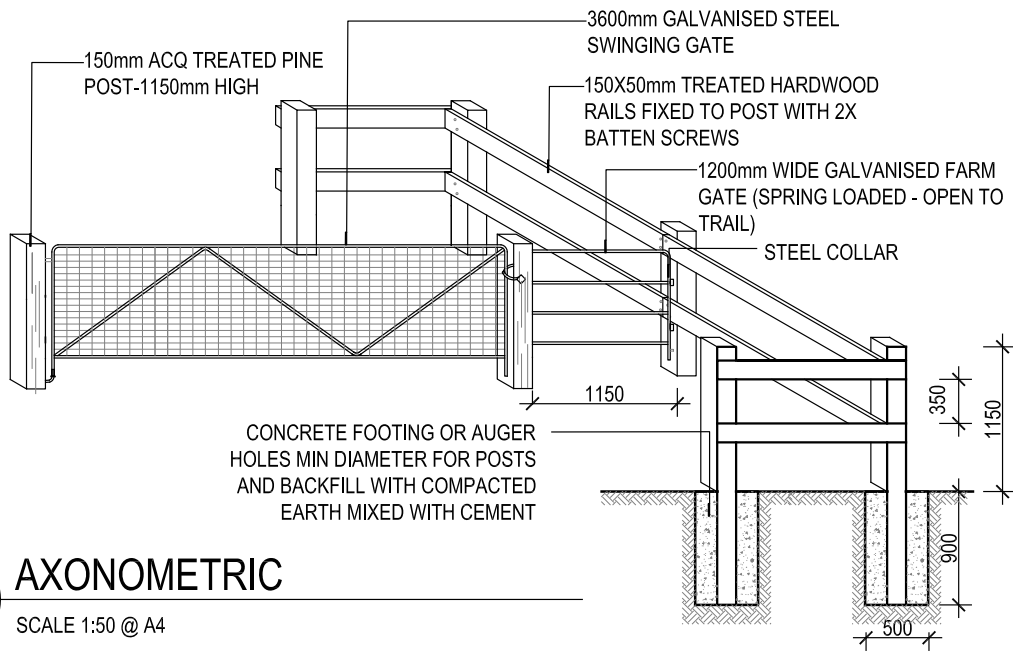

**APPENDIX 3 – TRAILHEAD DRAWINGS**



# MARY TO BAY RAIL TRAIL

## MARYBOROUGH TRAILHEAD

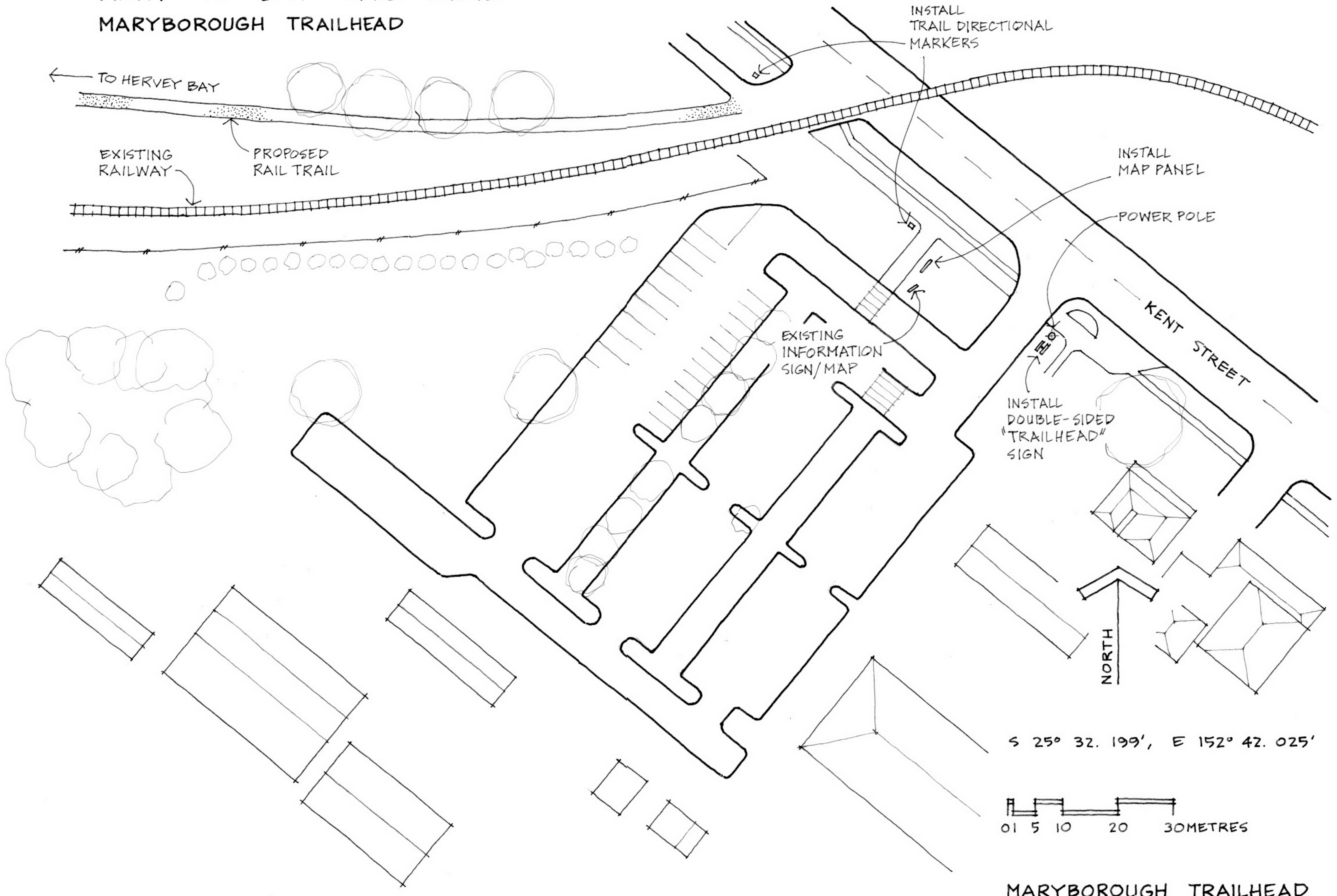

S 25° 32. 199', E 152° 42. 025'

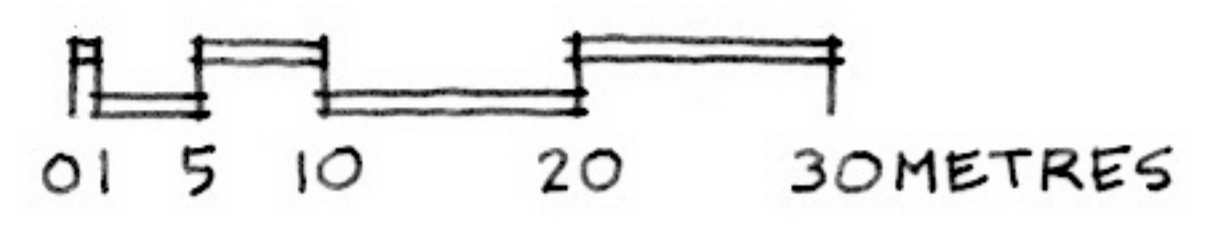

MARYBOROUGH TRAILHEAD



# MARY TO BAY RAIL TRAIL MARYBOROUGH WEST TRAILHEAD AND ROAD CROSSING

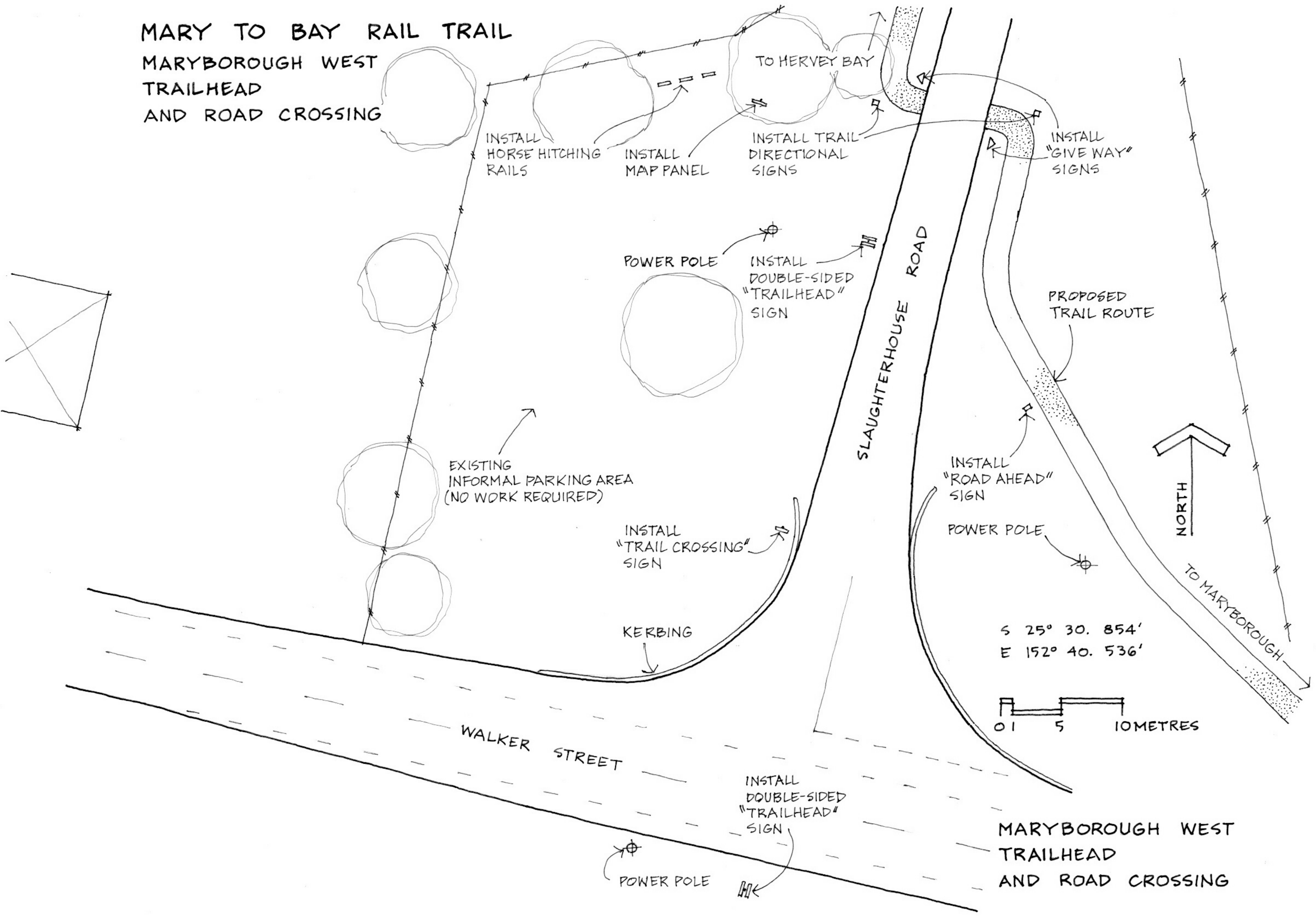



# MARY TO BAY RAIL TRAIL ALDRESHOT TRAILHEAD

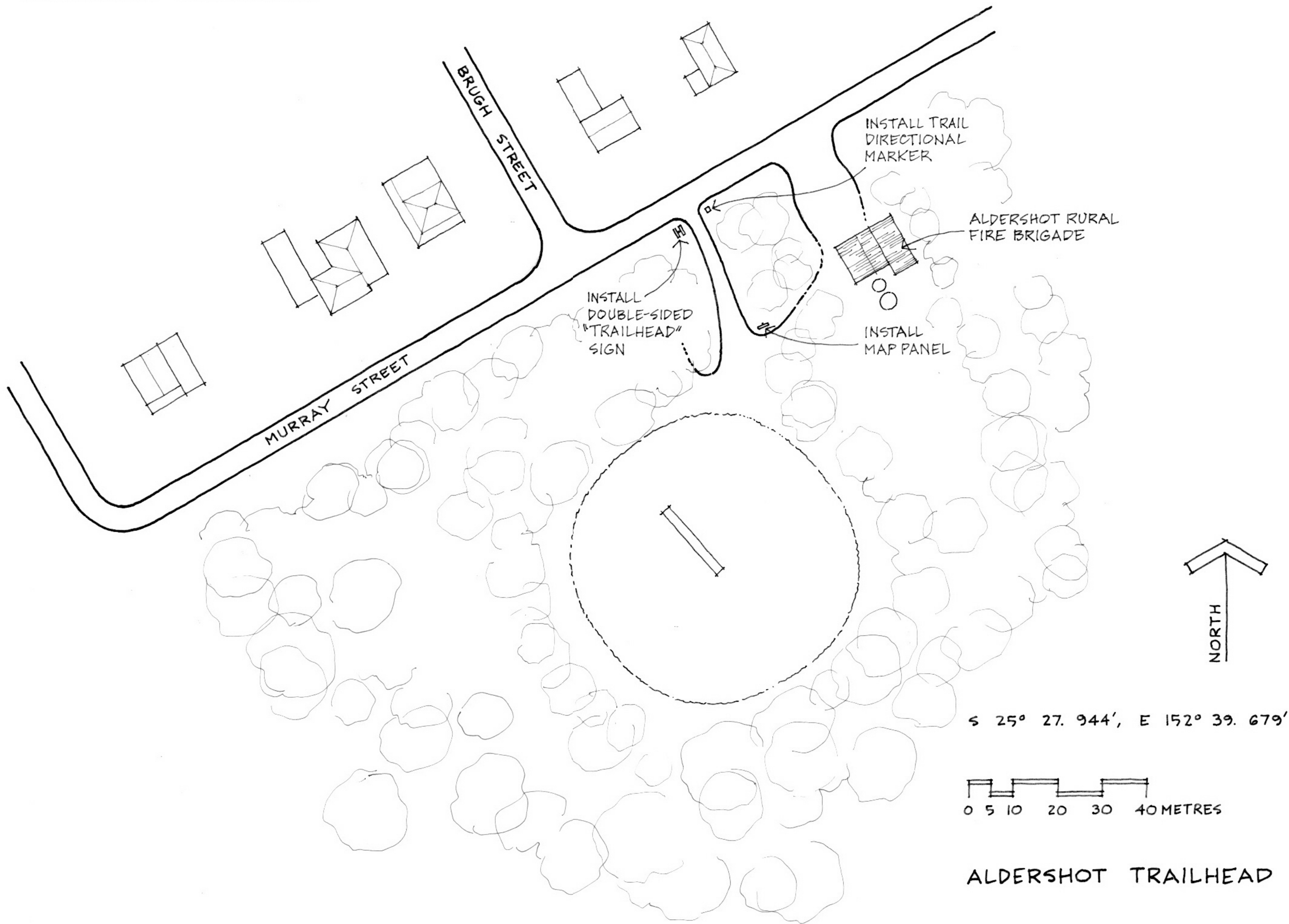

MARY TO BAY RAIL TRAIL  
 TRAILHEAD  
 CHURCHILL MINE ROAD

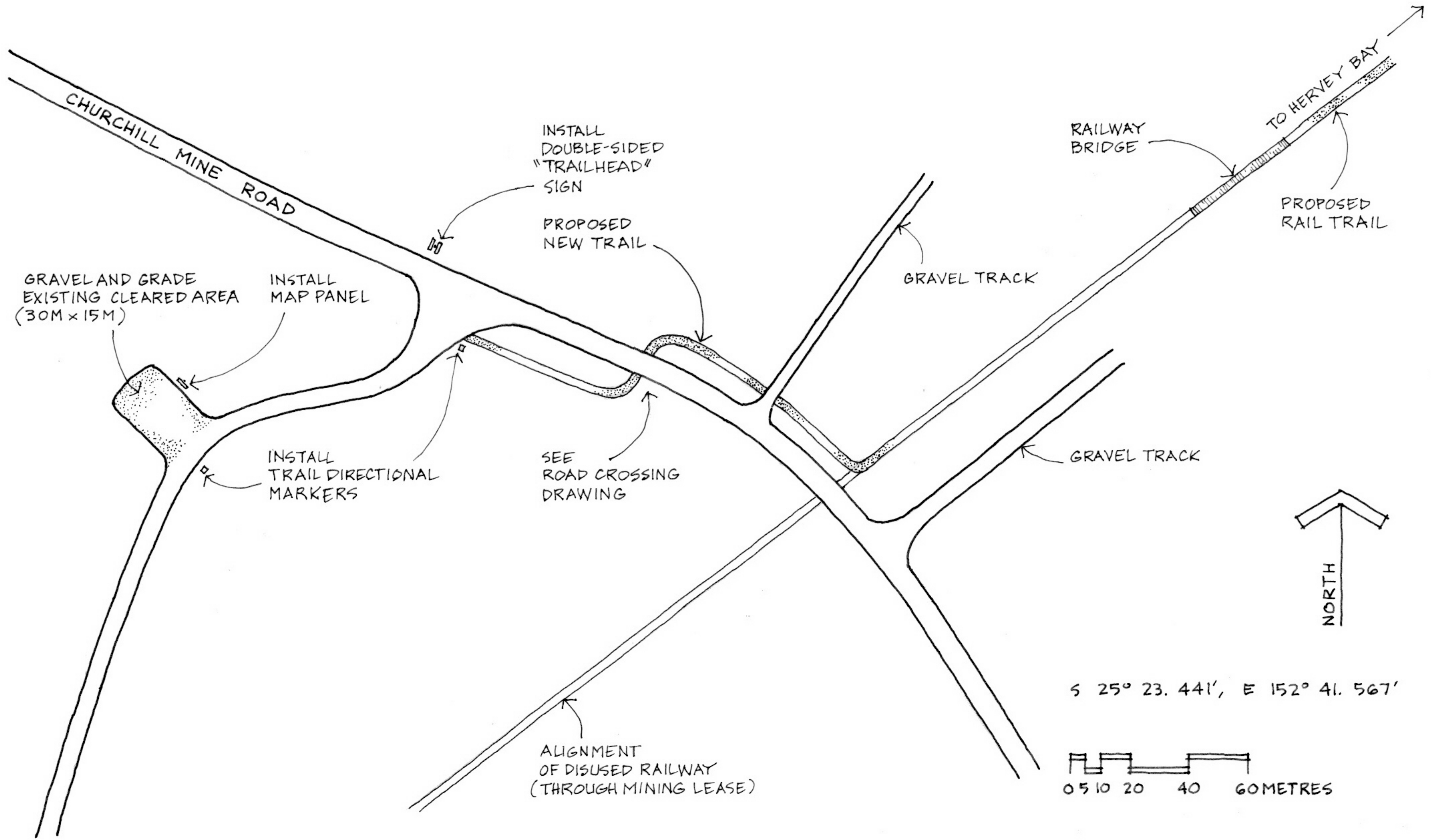

TRAILHEAD  
 CHURCHILL MINE ROAD



# MARY TO BAY RAIL TRAIL TAKURA TRAILHEAD

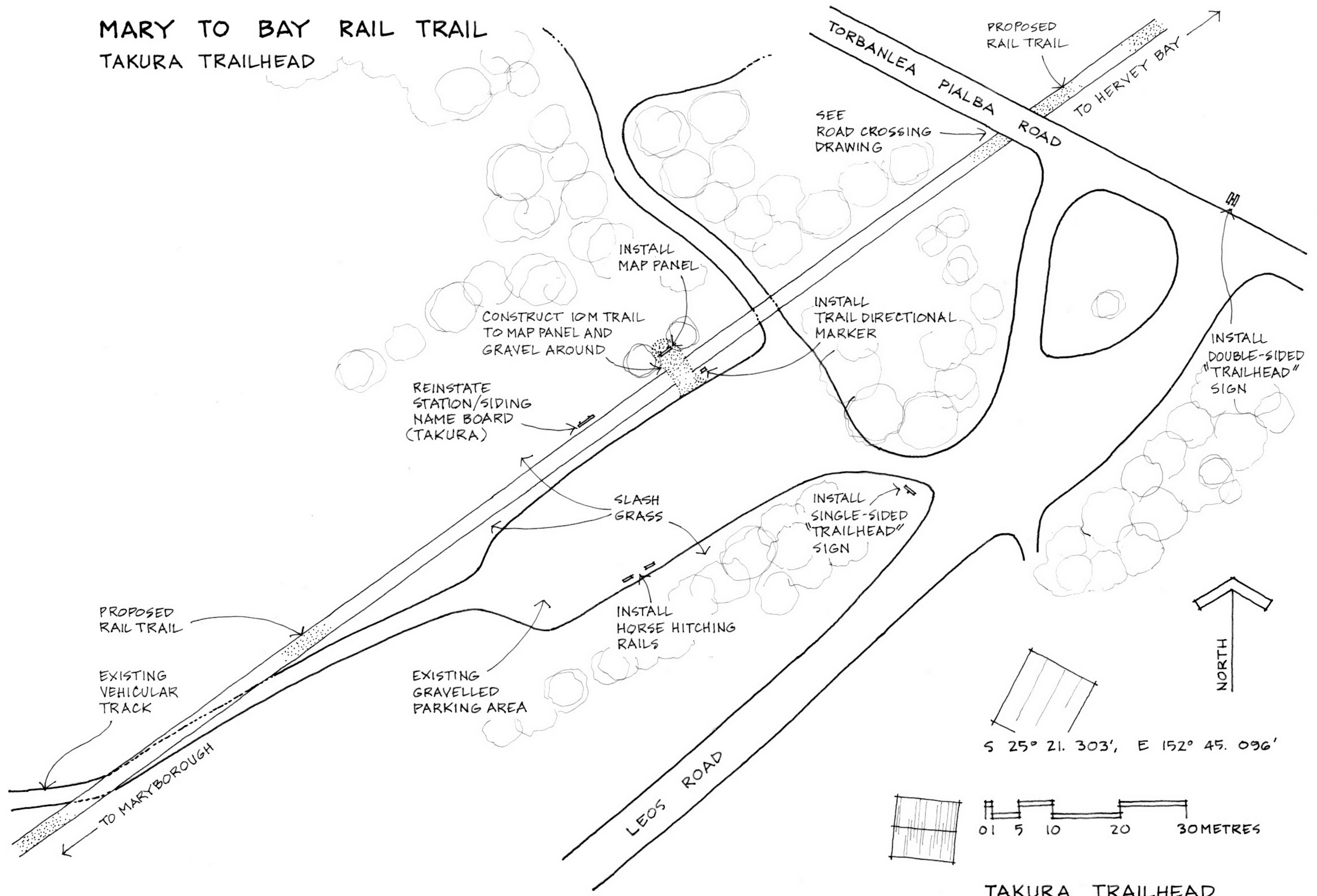

S 25° 21.303', E 152° 45.096'

01 5 10 20 30 METRES

TAKURA TRAILHEAD



# MARY TO BAY RAIL TRAIL WALLIGAN TRAILHEAD

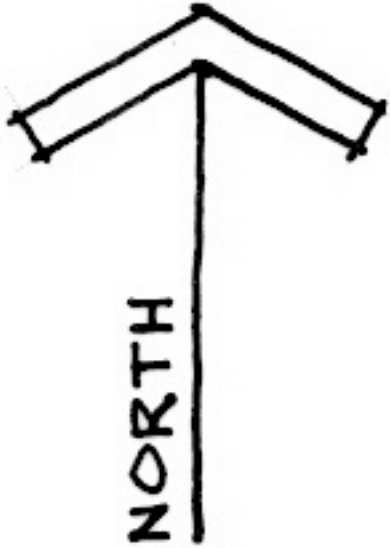
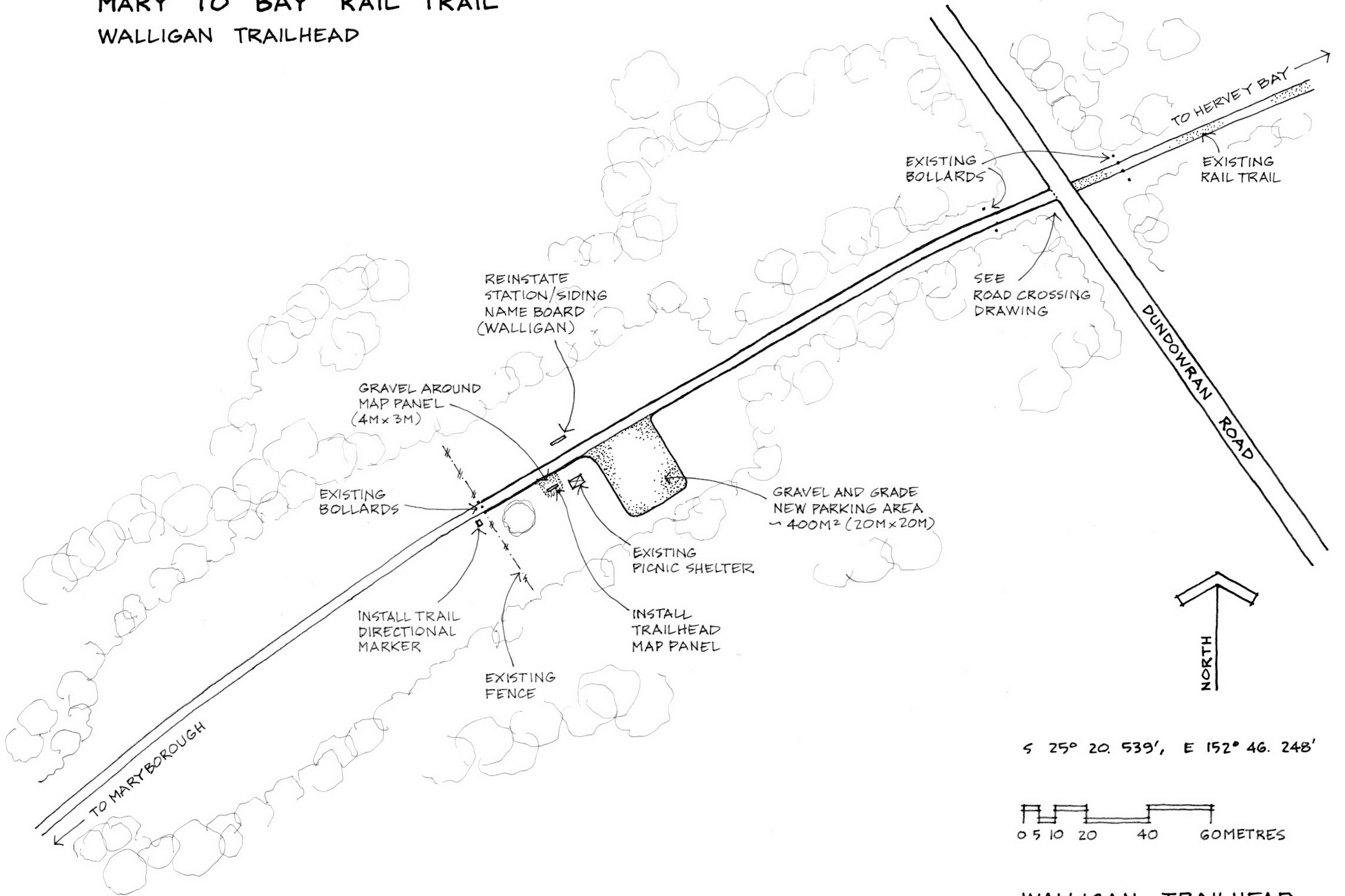

S 25° 20. 539', E 152° 46. 248'

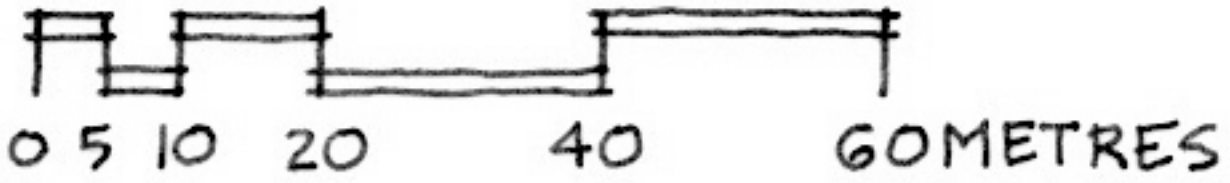

WALLIGAN TRAILHEAD

**APPENDIX 4 –TRAIL MAINTENANCE CHECKLIST: AN EXAMPLE**

### KEP TRACK MAINTENANCE CHECKLIST

The checklist that follows has been designed to be copied before each regular inspection, filled out and filed for future reference. It assumes the inspection will commence at Mt Helena and proceed in an easterly direction towards Wooroloo. This is an essential component of the maintenance program.

#### KEP TRACK (Mt Helena to Wooroloo) - MAINTENANCE CHECKLIST

Inspection Date (circle a year and tick one box):

- |                                       |                                       |  |                                       |
|---------------------------------------|---------------------------------------|--|---------------------------------------|
| <input type="checkbox"/> Jan 2005/6/7 | <input type="checkbox"/> Feb 2005/6/7 | <input type="checkbox"/> Mar. 2005/6/7 | <input type="checkbox"/> Apr 2005/6/7 |
| <input type="checkbox"/> May 2005/6/7 | <input type="checkbox"/> Jun 2005/6/7 | <input type="checkbox"/> Jul 2005/6/7  | <input type="checkbox"/> Aug 2004/5/6 |
| <input type="checkbox"/> Sep 2004/5/6 | <input type="checkbox"/> Oct 2004/5/6 | <input type="checkbox"/> Nov. 2004/5/6 | <input type="checkbox"/> Dec 2004/5/6 |

Actual Date: \_\_\_\_\_

Person undertaking inspection: \_\_\_\_\_ Signature: \_\_\_\_\_

LOCATION	ACTION REQUIRED	TICK IF OKAY	ACTION TAKEN (IF ANY)
Sawyers Road Crossing in Mt Helena	<ul style="list-style-type: none"> <li>• Check gate west side</li> <li>• Check directional markers</li> <li>• Check totems and signage</li> <li>• Check promotional signage</li> </ul>		
Johnston Street (Mt Helena)	<ul style="list-style-type: none"> <li>• Check gate west side</li> <li>• Check directional markers</li> <li>• Check totems and signage</li> </ul>		
Lion St crossing	<ul style="list-style-type: none"> <li>• Check gates both sides</li> <li>• Check interpretive sign (north west corner)</li> <li>• Check directional markers</li> <li>• Check totems and signage</li> <li>• Check promotional signage</li> </ul>		
Exit from Eastern Hills High School (crossing)	<ul style="list-style-type: none"> <li>• Check gate east side</li> <li>• Check directional markers</li> <li>• Check totems and signage</li> <li>• Check interpretive sign (opposite Sime Rd)</li> </ul>		
Thomas / Elliot road crossing	<ul style="list-style-type: none"> <li>• Check gates both sides</li> <li>• Check directional markers</li> <li>• Check totems and signage</li> <li>• Check promotional signage</li> <li>• Check interpretive sign (opposite booster station)</li> </ul>		
Chidlow Reserve	<ul style="list-style-type: none"> <li>• Check interpretive signs (at turnoff to Lake Leschenaultia; opposite standpipe; opposite stone building; at old interpretive shelter)</li> <li>• Check condition of new trail through reserve</li> </ul>		



## KEP TRACK (Mt Helena to Wooroloo) - MAINTENANCE CHECKLIST

LOCATION	ACTION REQUIRED	TICK IF OKAY	ACTION TAKEN (IF ANY)
Old Northam Rd (Chidlow)	<ul style="list-style-type: none"> <li>• Check gate east side</li> <li>• Check directional markers</li> <li>• Check totems and signage</li> <li>• Check promotional signage</li> <li>• Check culvert west side</li> <li>• Check ramps</li> <li>• Check interpretive sign (mid point between Old Northam Rd &amp; Ash Rd)</li> </ul>		
Ash Rd crossing	<ul style="list-style-type: none"> <li>• Check gates both sides</li> <li>• Check directional markers</li> <li>• Check totems and signage</li> <li>• Check promotional signage</li> </ul>		
Doconing Rd crossing	<ul style="list-style-type: none"> <li>• Check gates both sides</li> <li>• Check directional markers</li> <li>• Check totems and signage</li> <li>• Check promotional signage</li> <li>• Check interpretive sign (150 metres east of crossing)</li> </ul>		
Old Northam Rd crossing	<ul style="list-style-type: none"> <li>• Check gates both sides</li> <li>• Check directional markers</li> <li>• Check totems and signage</li> <li>• Check promotional signage</li> <li>• Check culverts (both sides)</li> <li>• Check interpretive sign (SW corner)</li> </ul>		
Entrance to horse trials paddocks	<ul style="list-style-type: none"> <li>• Check gates</li> <li>• Check directional markers</li> <li>• Check totems and signage</li> <li>• Check road warning signs</li> </ul>		
Government Rd crossing	<ul style="list-style-type: none"> <li>• Check gates both sides</li> <li>• Check directional markers</li> <li>• Check totems and signage</li> <li>• Check new 40 metre section of trail at road crossing</li> </ul>		
Government Road to Green St	<ul style="list-style-type: none"> <li>• Check interpretive sign (where pipeline crosses trail)</li> <li>• Check interpretive sign (opposite Jason St)</li> </ul>		
Green Street	<ul style="list-style-type: none"> <li>• Check gates both sides</li> <li>• Check directional markers</li> <li>• Check totems and signage</li> </ul>		
Any additional work required?			
Hazard Inspection	Whole trail - annually		
Annual budget allocation	Discuss with staff		

APPENDIX 5 - PLANS OF PROPOSED RAIL TRAIL



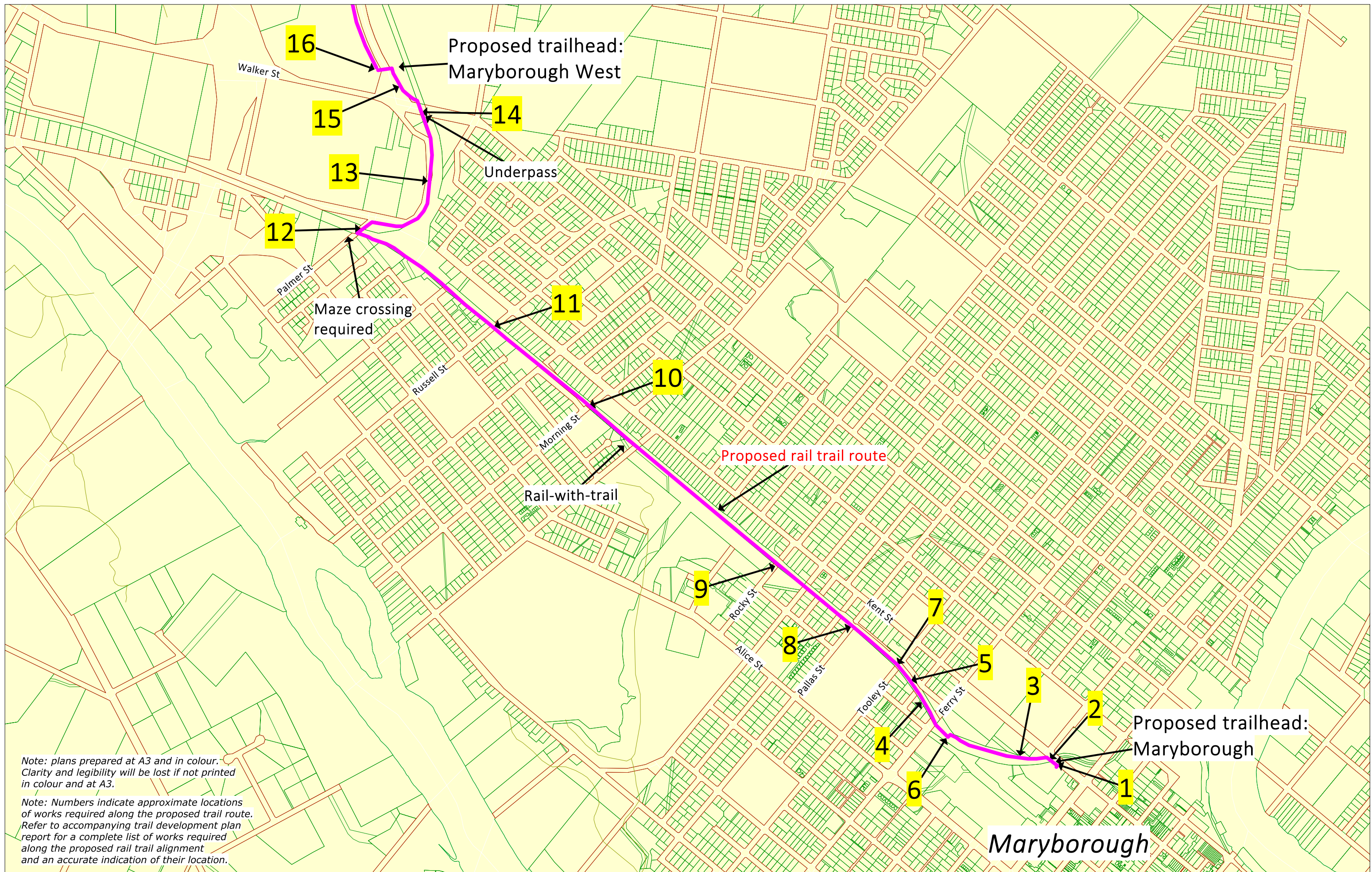

Note: plans prepared at A3 and in colour. Clarity and legibility will be lost if not printed in colour and at A3.

Note: Numbers indicate approximate locations of works required along the proposed trail route. Refer to accompanying trail development plan report for a complete list of works required along the proposed rail trail alignment and an accurate indication of their location.



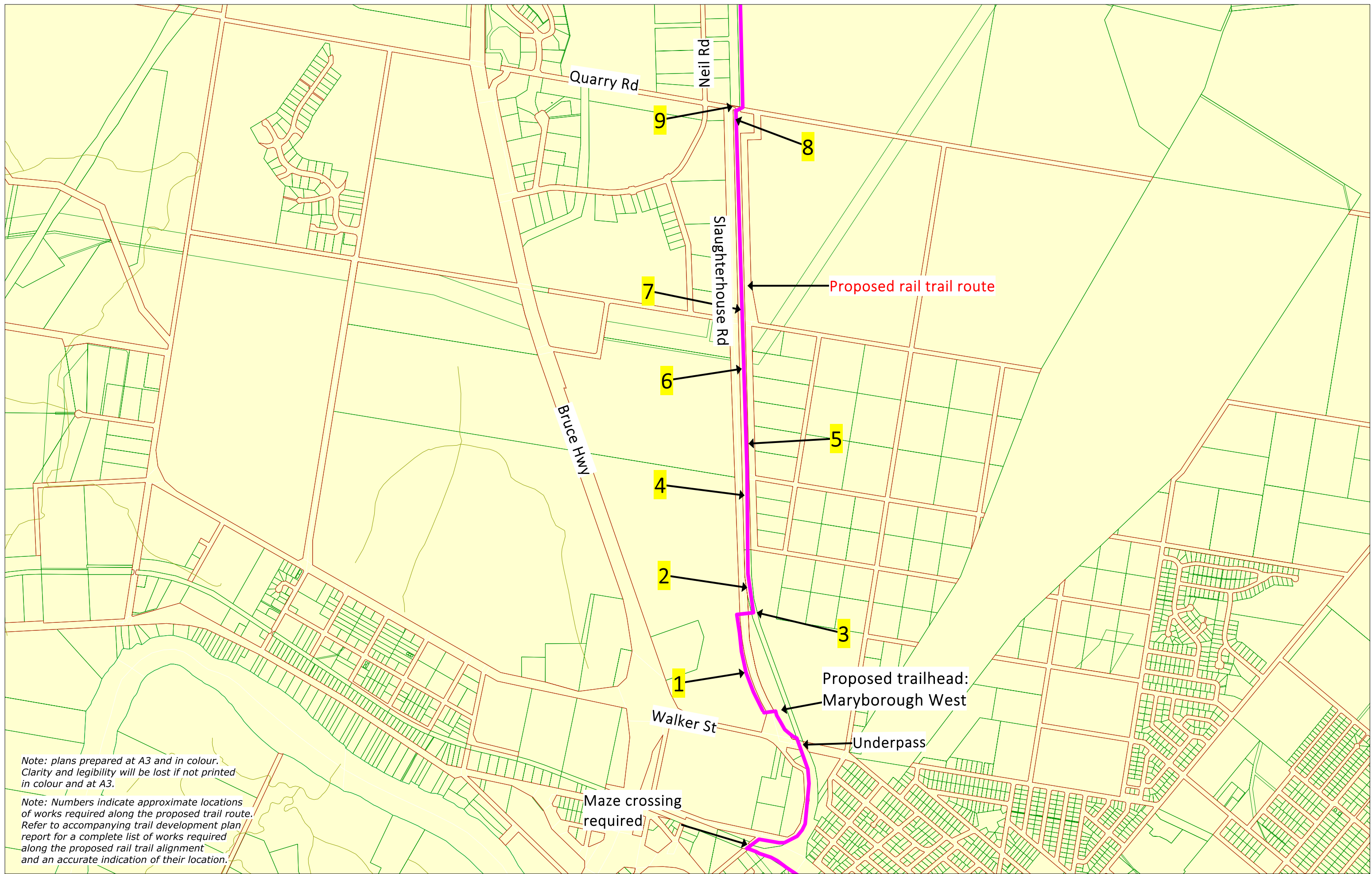

Note: plans prepared at A3 and in colour. Clarity and legibility will be lost if not printed in colour and at A3.

Note: Numbers indicate approximate locations of works required along the proposed trail route. Refer to accompanying trail development plan report for a complete list of works required along the proposed rail trail alignment and an accurate indication of their location.

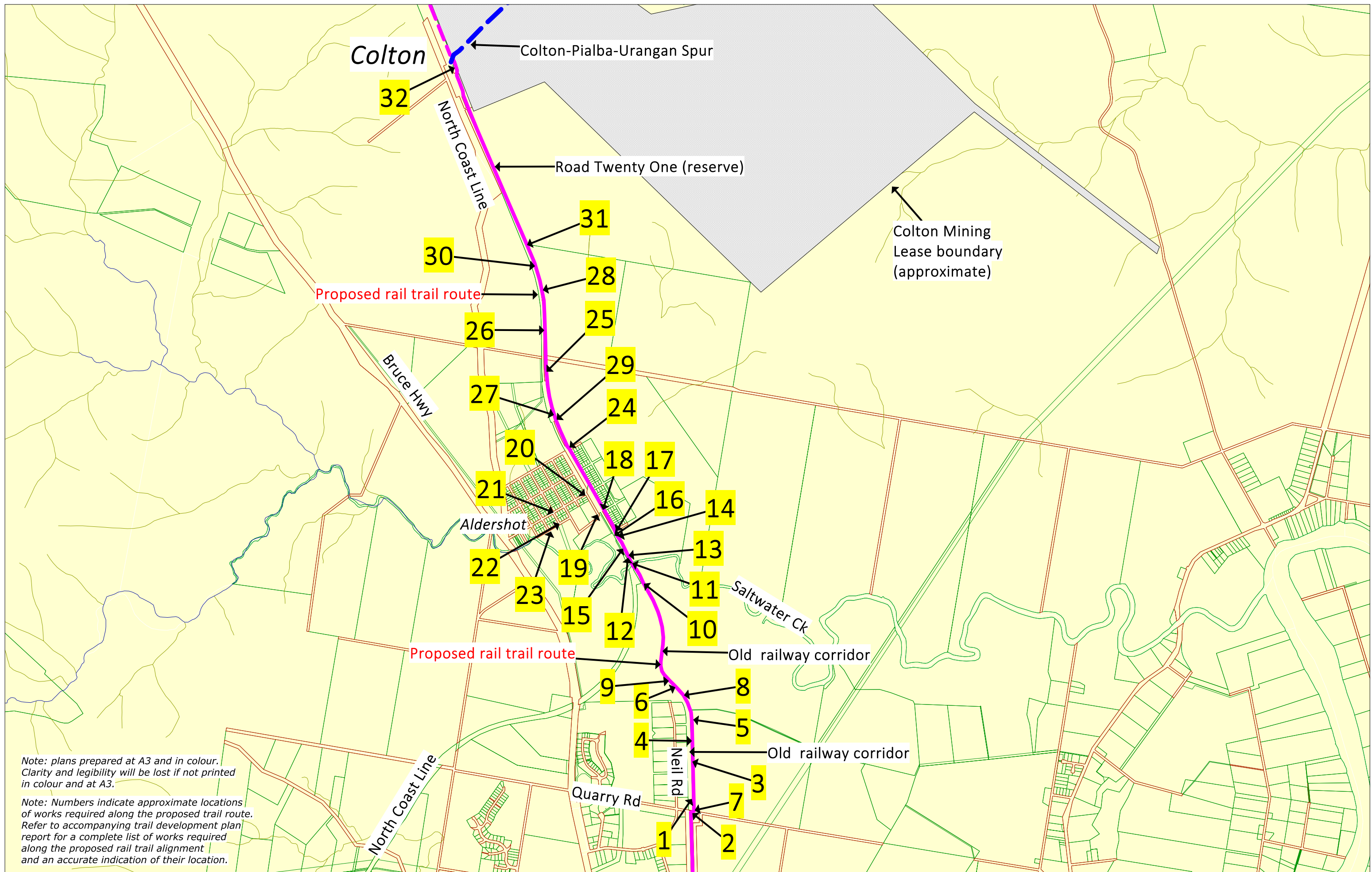

Note: plans prepared at A3 and in colour. Clarity and legibility will be lost if not printed in colour and at A3.

Note: Numbers indicate approximate locations of works required along the proposed trail route. Refer to accompanying trail development plan report for a complete list of works required along the proposed rail trail alignment and an accurate indication of their location.







